

**NATIONWIDE PERMIT 14
DEPARTMENT OF THE ARMY
CORPS OF ENGINEERS
FINAL NOTICE OF ISSUANCE AND MODIFICATION OF NATIONWIDE PERMITS
FEDERAL REGISTER
AUTHORIZED MARCH 19, 2017**

Linear Transportation Projects. Activities required for crossings of waters of the United States associated with the construction, expansion, modification, or improvement of linear transportation projects (e.g., roads, highways, railways, trails, airport runways, and taxiways) in waters of the United States. For linear transportation projects in non-tidal waters, the discharge cannot cause the loss of greater than 1/2-acre of waters of the United States. For linear transportation projects in tidal waters, the discharge cannot cause the loss of greater than 1/3-acre of waters of the United States. Any stream channel modification, including bank stabilization, is limited to the minimum necessary to construct or protect the linear transportation project; such modifications must be in the immediate vicinity of the project.

This NWP also authorizes temporary structures, fills, and work, including the use of temporary mats, necessary to construct the linear transportation project. Appropriate measures must be taken to maintain normal downstream flows and minimize flooding to the maximum extent practicable, when temporary structures, work, and discharges, including cofferdams, are necessary for construction activities, access fills, or dewatering of construction sites. Temporary fills must consist of materials, and be placed in a manner, that will not be eroded by expected high flows. Temporary fills must be removed in their entirety and the affected areas returned to pre-construction elevations. The areas affected by temporary fills must be revegetated, as appropriate.

This NWP cannot be used to authorize non-linear features commonly associated with transportation projects, such as vehicle maintenance or storage buildings, parking lots, train stations, or aircraft hangars.

Notification: The permittee must submit a pre-construction notification to the district engineer prior to commencing the activity if: (1) the loss of waters of the United States exceeds 1/10-acre; or (2) there is a discharge in a special aquatic site, including wetlands. (See general condition 32.) (Authorities: Sections 10 and 404)

Note 1: For linear transportation projects crossing a single waterbody more than one time at separate and distant locations, or multiple waterbodies at separate and distant locations, each crossing is considered a single and complete project for purposes of NWP authorization. Linear transportation projects must comply with 33 CFR 330.6(d).

Note 2: Some discharges for the construction of farm roads or forest roads, or temporary roads for moving mining equipment, may qualify for an exemption under section 404(f) of the Clean Water Act (see 33 CFR 323.4).

Note 3: For NWP 14 activities that require pre-construction notification, the PCN must include any other NWP(s), regional general permit(s), or individual permit(s) used or intended

to be used to authorize any part of the proposed project or any related activity, including other separate and distant crossings that require Department of the Army authorization but do not require pre-construction notification (see paragraph (b) of general condition 32). The district engineer will evaluate the PCN in accordance with Section D, "District Engineer's Decision." The district engineer may require mitigation to ensure that the authorized activity results in no more than minimal individual and cumulative adverse environmental effects (see general condition 23).

NATIONWIDE PERMIT GENERAL CONDITIONS

The following General Conditions must be followed in order for any authorization by a NWP to be valid:

1. Navigation. (a) No activity may cause more than a minimal adverse effect on navigation.
(b) Any safety lights and signals prescribed by the U.S. Coast Guard, through regulations or otherwise, must be installed and maintained at the permittee's expense on authorized facilities in navigable waters of the United States.
(c) The permittee understands and agrees that, if future operations by the United States require the removal, relocation, or other alteration, of the structure or work herein authorized, or if, in the opinion of the Secretary of the Army or his authorized representative, said structure or work shall cause unreasonable obstruction to the free navigation of the navigable waters, the permittee will be required, upon due notice from the Corps of Engineers, to remove, relocate, or alter the structural work or obstructions caused thereby, without expense to the United States. No claim shall be made against the United States on account of any such removal or alteration.

2. Aquatic Life Movements. No activity may substantially disrupt the necessary life cycle movements of those species of aquatic life indigenous to the waterbody, including those species that normally migrate through the area, unless the activity's primary purpose is to impound water. All permanent and temporary crossings of waterbodies shall be suitably culverted, bridged, or otherwise designed and constructed to maintain low flows to sustain the movement of those aquatic species. If a bottomless culvert cannot be used, then the crossing should be designed and constructed to minimize adverse effects to aquatic life movements.

3. Spawning Areas. Activities in spawning areas during spawning seasons must be avoided to the maximum extent practicable. Activities that result in the physical destruction (e.g., through excavation, fill, or downstream smothering by substantial turbidity) of an important spawning area are not authorized.

4. Migratory Bird Breeding Areas. Activities in waters of the United States that serve as breeding areas for migratory birds must be avoided to the maximum extent practicable.

5. Shellfish Beds. No activity may occur in areas of concentrated shellfish populations, unless the activity is directly related to a shellfish harvesting activity authorized by NWPs 4 and 48, or is a shellfish seeding or habitat restoration activity authorized by NWP 27.

6. Suitable Material. No activity may use unsuitable material (e.g., trash, debris, car bodies, asphalt, etc.). Material used for construction or discharged must be free from toxic pollutants in toxic amounts (see section 307 of the Clean Water Act).

7. Water Supply Intakes. No activity may occur in the proximity of a public water supply intake, except where the activity is for the repair or improvement of public water supply intake structures or adjacent bank stabilization.

8. Adverse Effects From Impoundments. If the activity creates an impoundment of water, adverse effects to the aquatic system due to accelerating the passage of water, and/or restricting its flow must be minimized to the maximum extent practicable.

9. Management of Water Flows. To the maximum extent practicable, the pre-construction course, condition, capacity, and location of open waters must be maintained for each activity, including stream channelization, storm water management activities, and temporary and permanent road crossings, except as provided below. The activity must be constructed to withstand expected high flows. The activity must not restrict or impede the passage of normal or high flows, unless the primary purpose of the activity is to impound water or manage high flows. The activity may alter the pre-construction course, condition, capacity, and location of open waters if it benefits the aquatic environment (e.g., stream restoration or relocation activities).

10. Fills Within 100-Year Floodplains. The activity must comply with applicable FEMA-approved state or local floodplain management requirements.

11. Equipment. Heavy equipment working in wetlands or mudflats must be placed on mats, or other measures must be taken to minimize soil disturbance.

12. Soil Erosion and Sediment Controls. Appropriate soil erosion and sediment controls must be used and maintained in effective operating condition during construction, and all exposed soil and other fills, as well as any work below the ordinary high water mark or high tide line, must be permanently stabilized at the earliest practicable date. Permittees are encouraged to perform work within waters of the United States during periods of low-flow or no-flow, or during low tides.

13. Removal of Temporary Fills. Temporary fills must be removed in their entirety and the affected areas returned to pre-construction elevations. The affected areas must be revegetated, as appropriate.

14. Proper Maintenance. Any authorized structure or fill shall be properly maintained, including maintenance to ensure public safety and compliance with applicable NWP general conditions, as well as any activity-specific conditions added by the district engineer to an NWP authorization.

15. Single and Complete Project. The activity must be a single and complete project. The same NWP cannot be used more than once for the same single and complete project.

16. Wild and Scenic Rivers. (a) No NWP activity may occur in a component of the National Wild and Scenic River System, or in a river officially designated by Congress as a “study river” for possible inclusion in the system while the river is in an official study status,

unless the appropriate Federal agency with direct management responsibility for such river, has determined in writing that the proposed activity will not adversely affect the Wild and Scenic River designation or study status.

(b) If a proposed NWP activity will occur in a component of the National Wild and Scenic River System, or in a river officially designated by Congress as a “study river” for possible inclusion in the system while the river is in an official study status, the permittee must submit a pre-construction notification (see general condition 32). The district engineer will coordinate the PCN with the Federal agency with direct management responsibility for that river. The permittee shall not begin the NWP activity until notified by the district engineer that the Federal agency with direct management responsibility for that river has determined in writing that the proposed NWP activity will not adversely affect the Wild and Scenic River designation or study status.

(c) Information on Wild and Scenic Rivers may be obtained from the appropriate Federal land management agency responsible for the designated Wild and Scenic River or study river (e.g., National Park Service, U.S. Forest Service, Bureau of Land Management, U.S. Fish and Wildlife Service). Information on these rivers is also available at: <http://www.rivers.gov/>.

17. Tribal Rights. No NWP activity may cause more than minimal adverse effects on tribal rights (including treaty rights), protected tribal resources, or tribal lands.

18. Endangered Species. (a) No activity is authorized under any NWP which is likely to directly or indirectly jeopardize the continued existence of a threatened or endangered species or a species proposed for such designation, as identified under the Federal Endangered Species Act (ESA), or which will directly or indirectly destroy or adversely modify the critical habitat of such species. No activity is authorized under any NWP which “may affect” a listed species or critical habitat, unless ESA section 7 consultation addressing the effects of the proposed activity has been completed. Direct effects are the immediate effects on listed species and critical habitat caused by the NWP activity. Indirect effects are those effects on listed species and critical habitat that are caused by the NWP activity and are later in time, but still are reasonably certain to occur.

(b) Federal agencies should follow their own procedures for complying with the requirements of the ESA. If pre-construction notification is required for the proposed activity, the Federal permittee must provide the district engineer with the appropriate documentation to demonstrate compliance with those requirements. The district engineer will verify that the appropriate documentation has been submitted. If the appropriate documentation has not been submitted, additional ESA section 7 consultation may be necessary for the activity and the respective federal agency would be responsible for fulfilling its obligation under section 7 of the ESA.

(c) Non-federal permittees must submit a pre-construction notification to the district engineer if any listed species or designated critical habitat might be affected or is in the vicinity of the activity, or if the activity is located in designated critical habitat, and shall not begin work on the activity until notified by the district engineer that the requirements of the ESA have been satisfied and that the activity is authorized. For activities that might affect Federally-listed endangered or threatened species or designated critical habitat, the pre-construction notification must include the name(s) of the endangered or threatened species that

might be affected by the proposed activity or that utilize the designated critical habitat that might be affected by the proposed activity. The district engineer will determine whether the proposed activity “may affect” or will have “no effect” to listed species and designated critical habitat and will notify the non-Federal applicant of the Corps’ determination within 45 days of receipt of a complete pre-construction notification. In cases where the non-Federal applicant has identified listed species or critical habitat that might be affected or is in the vicinity of the activity, and has so notified the Corps, the applicant shall not begin work until the Corps has provided notification that the proposed activity will have “no effect” on listed species or critical habitat, or until ESA section 7 consultation has been completed. If the non-Federal applicant has not heard back from the Corps within 45 days, the applicant must still wait for notification from the Corps.

(d) As a result of formal or informal consultation with the FWS or NMFS the district engineer may add species-specific permit conditions to the NWP.

(e) Authorization of an activity by an NWP does not authorize the “take” of a threatened or endangered species as defined under the ESA. In the absence of separate authorization (e.g., an ESA Section 10 Permit, a Biological Opinion with “incidental take” provisions, etc.) from the FWS or the NMFS, the Endangered Species Act prohibits any person subject to the jurisdiction of the United States to take a listed species, where “take” means to harass, harm, pursue, hunt, shoot, wound, kill, trap, capture, or collect, or to attempt to engage in any such conduct. The word “harm” in the definition of “take” means an act which actually kills or injures wildlife. Such an act may include significant habitat modification or degradation where it actually kills or injures wildlife by significantly impairing essential behavioral patterns, including breeding, feeding or sheltering.

(f) If the non-federal permittee has a valid ESA section 10(a)(1)(B) incidental take permit with an approved Habitat Conservation Plan for a project or a group of projects that includes the proposed NWP activity, the non-federal applicant should provide a copy of that ESA section 10(a)(1)(B) permit with the PCN required by paragraph (c) of this general condition. The district engineer will coordinate with the agency that issued the ESA section 10(a)(1)(B) permit to determine whether the proposed NWP activity and the associated incidental take were considered in the internal ESA section 7 consultation conducted for the ESA section 10(a)(1)(B) permit. If that coordination results in concurrence from the agency that the proposed NWP activity and the associated incidental take were considered in the internal ESA section 7 consultation for the ESA section 10(a)(1)(B) permit, the district engineer does not need to conduct a separate ESA section 7 consultation for the proposed NWP activity. The district engineer will notify the non-federal applicant within 45 days of receipt of a complete pre-construction notification whether the ESA section 10(a)(1)(B) permit covers the proposed NWP activity or whether additional ESA section 7 consultation is required.

(g) Information on the location of threatened and endangered species and their critical habitat can be obtained directly from the offices of the FWS and NMFS or their world wide web pages at <http://www.fws.gov/> or <http://www.fws.gov/ipac> and <http://www.nmfs.noaa.gov/pr/species/esa/> respectively.

19. Migratory Birds and Bald and Golden Eagles. The permittee is responsible for ensuring their action complies with the Migratory Bird Treaty Act and the Bald and Golden Eagle Protection Act. The permittee is responsible for contacting appropriate local office of the U.S. Fish and Wildlife Service to determine applicable measures to reduce impacts to migratory

birds or eagles, including whether “incidental take” permits are necessary and available under the Migratory Bird Treaty Act or Bald and Golden Eagle Protection Act for a particular activity.

20. Historic Properties. (a) In cases where the district engineer determines that the activity may have the potential to cause effects to properties listed, or eligible for listing, in the National Register of Historic Places, the activity is not authorized, until the requirements of Section 106 of the National Historic Preservation Act (NHPA) have been satisfied.

(b) Federal permittees should follow their own procedures for complying with the requirements of section 106 of the National Historic Preservation Act. If pre-construction notification is required for the proposed NWP activity, the Federal permittee must provide the district engineer with the appropriate documentation to demonstrate compliance with those requirements. The district engineer will verify that the appropriate documentation has been submitted. If the appropriate documentation is not submitted, then additional consultation under section 106 may be necessary. The respective federal agency is responsible for fulfilling its obligation to comply with section 106.

(c) Non-federal permittees must submit a pre-construction notification to the district engineer if the NWP activity might have the potential to cause effects to any historic properties listed on, determined to be eligible for listing on, or potentially eligible for listing on the National Register of Historic Places, including previously unidentified properties. For such activities, the pre-construction notification must state which historic properties might have the potential to be affected by the proposed NWP activity or include a vicinity map indicating the location of the historic properties or the potential for the presence of historic properties. Assistance regarding information on the location of, or potential for, the presence of historic properties can be sought from the State Historic Preservation Officer, Tribal Historic Preservation Officer, or designated tribal representative, as appropriate, and the National Register of Historic Places (see 33 CFR 330.4(g)). When reviewing pre-construction notifications, district engineers will comply with the current procedures for addressing the requirements of section 106 of the National Historic Preservation Act. The district engineer shall make a reasonable and good faith effort to carry out appropriate identification efforts, which may include background research, consultation, oral history interviews, sample field investigation, and field survey. Based on the information submitted in the PCN and these identification efforts, the district engineer shall determine whether the proposed NWP activity has the potential to cause effects on the historic properties. Section 106 consultation is not required when the district engineer determines that the activity does not have the potential to cause effects on historic properties (see 36 CFR 800.3(a)). Section 106 consultation is required when the district engineer determines that the activity has the potential to cause effects on historic properties. The district engineer will conduct consultation with consulting parties identified under 36 CFR 800.2(c) when he or she makes any of the following effect determinations for the purposes of section 106 of the NHPA: no historic properties affected, no adverse effect, or adverse effect. Where the non-Federal applicant has identified historic properties on which the activity might have the potential to cause effects and so notified the Corps, the non-Federal applicant shall not begin the activity until notified by the district engineer either that the activity has no potential to cause effects to historic properties or that NHPA section 106 consultation has been completed.

(d) For non-federal permittees, the district engineer will notify the prospective permittee within 45 days of receipt of a complete pre-construction notification whether NHPA section 106 consultation is required. If NHPA section 106 consultation is required, the district engineer will notify the non-Federal applicant that he or she cannot begin the activity until section 106 consultation is completed. If the non-Federal applicant has not heard back from the Corps within 45 days, the applicant must still wait for notification from the Corps.

(e) Prospective permittees should be aware that section 110k of the NHPA (54 U.S.C. 306113) prevents the Corps from granting a permit or other assistance to an applicant who, with intent to avoid the requirements of section 106 of the NHPA, has intentionally significantly adversely affected a historic property to which the permit would relate, or having legal power to prevent it, allowed such significant adverse effect to occur, unless the Corps, after consultation with the Advisory Council on Historic Preservation (ACHP), determines that circumstances justify granting such assistance despite the adverse effect created or permitted by the applicant. If circumstances justify granting the assistance, the Corps is required to notify the ACHP and provide documentation specifying the circumstances, the degree of damage to the integrity of any historic properties affected, and proposed mitigation. This documentation must include any views obtained from the applicant, SHPO/THPO, appropriate Indian tribes if the undertaking occurs on or affects historic properties on tribal lands or affects properties of interest to those tribes, and other parties known to have a legitimate interest in the impacts to the permitted activity on historic properties.

21. Discovery of Previously Unknown Remains and Artifacts. If you discover any previously unknown historic, cultural or archeological remains and artifacts while accomplishing the activity authorized by this permit, you must immediately notify the district engineer of what you have found, and to the maximum extent practicable, avoid construction activities that may affect the remains and artifacts until the required coordination has been completed. The district engineer will initiate the Federal, Tribal, and state coordination required to determine if the items or remains warrant a recovery effort or if the site is eligible for listing in the National Register of Historic Places.

22. Designated Critical Resource Waters. Critical resource waters include, NOAA-managed marine sanctuaries and marine monuments, and National Estuarine Research Reserves. The district engineer may designate, after notice and opportunity for public comment, additional waters officially designated by a state as having particular environmental or ecological significance, such as outstanding national resource waters or state natural heritage sites. The district engineer may also designate additional critical resource waters after notice and opportunity for public comment.

(a) Discharges of dredged or fill material into waters of the United States are not authorized by NWPs 7, 12, 14, 16, 17, 21, 29, 31, 35, 39, 40, 42, 43, 44, 49, 50, 51, and 52 for any activity within, or directly affecting, critical resource waters, including wetlands adjacent to such waters.

(b) For NWPs 3, 8, 10, 13, 15, 18, 19, 22, 23, 25, 27, 28, 30, 33, 34, 36, 37, 38, and 54, notification is required in accordance with general condition 32, for any activity proposed in the designated critical resource waters including wetlands adjacent to those waters. The district engineer may authorize activities under these NWPs only after it is determined that the impacts to the critical resource waters will be no more than minimal.

23. Mitigation. The district engineer will consider the following factors when determining appropriate and practicable mitigation necessary to ensure that the individual and cumulative adverse environmental effects are no more than minimal:

(a) The activity must be designed and constructed to avoid and minimize adverse effects, both temporary and permanent, to waters of the United States to the maximum extent practicable at the project site (i.e., on site).

(b) Mitigation in all its forms (avoiding, minimizing, rectifying, reducing, or compensating for resource losses) will be required to the extent necessary to ensure that the individual and cumulative adverse environmental effects are no more than minimal.

(c) Compensatory mitigation at a minimum one-for-one ratio will be required for all wetland losses that exceed 1/10-acre and require pre-construction notification, unless the district engineer determines in writing that either some other form of mitigation would be more environmentally appropriate or the adverse environmental effects of the proposed activity are no more than minimal, and provides an activity-specific waiver of this requirement. For wetland losses of 1/10-acre or less that require pre-construction notification, the district engineer may determine on a case-by-case basis that compensatory mitigation is required to ensure that the activity results in only minimal adverse environmental effects.

(d) For losses of streams or other open waters that require pre-construction notification, the district engineer may require compensatory mitigation to ensure that the activity results in no more than minimal adverse environmental effects. Compensatory mitigation for losses of streams should be provided, if practicable, through stream rehabilitation, enhancement, or preservation, since streams are difficult-to-replace resources (see 33 CFR 332.3(e)(3)).

(e) Compensatory mitigation plans for NWP activities in or near streams or other open waters will normally include a requirement for the restoration or enhancement, maintenance, and legal protection (e.g., conservation easements) of riparian areas next to open waters. In some cases, the restoration or maintenance/protection of riparian areas may be the only compensatory mitigation required. Restored riparian areas should consist of native species. The width of the required riparian area will address documented water quality or aquatic habitat loss concerns. Normally, the riparian area will be 25 to 50 feet wide on each side of the stream, but the district engineer may require slightly wider riparian areas to address documented water quality or habitat loss concerns. If it is not possible to restore or maintain/protect a riparian area on both sides of a stream, or if the waterbody is a lake or coastal waters, then restoring or maintaining/protecting a riparian area along a single bank or shoreline may be sufficient. Where both wetlands and open waters exist on the project site, the district engineer will determine the appropriate compensatory mitigation (e.g., riparian areas and/or wetlands compensation) based on what is best for the aquatic environment on a watershed basis. In cases where riparian areas are determined to be the most appropriate form of minimization or compensatory mitigation, the district engineer may waive or reduce the requirement to provide wetland compensatory mitigation for wetland losses.

(f) Compensatory mitigation projects provided to offset losses of aquatic resources must comply with the applicable provisions of 33 CFR part 332.

(1) The prospective permittee is responsible for proposing an appropriate compensatory mitigation option if compensatory mitigation is necessary to ensure that the activity results in no more than minimal adverse environmental effects. For the NWPs, the preferred mechanism for providing compensatory mitigation is mitigation bank credits or in-

lieu fee program credits (see 33 CFR 332.3(b)(2) and (3)). However, if an appropriate number and type of mitigation bank or in-lieu credits are not available at the time the PCN is submitted to the district engineer, the district engineer may approve the use of permittee-responsible mitigation.

(2) The amount of compensatory mitigation required by the district engineer must be sufficient to ensure that the authorized activity results in no more than minimal individual and cumulative adverse environmental effects (see 33 CFR 330.1(e)(3)). (See also 33 CFR 332.3(f)).

(3) Since the likelihood of success is greater and the impacts to potentially valuable uplands are reduced, aquatic resource restoration should be the first compensatory mitigation option considered for permittee-responsible mitigation.

(4) If permittee-responsible mitigation is the proposed option, the prospective permittee is responsible for submitting a mitigation plan. A conceptual or detailed mitigation plan may be used by the district engineer to make the decision on the NWP verification request, but a final mitigation plan that addresses the applicable requirements of 33 CFR 332.4(c)(2) through (14) must be approved by the district engineer before the permittee begins work in waters of the United States, unless the district engineer determines that prior approval of the final mitigation plan is not practicable or not necessary to ensure timely completion of the required compensatory mitigation (see 33 CFR 332.3(k)(3)).

(5) If mitigation bank or in-lieu fee program credits are the proposed option, the mitigation plan only needs to address the baseline conditions at the impact site and the number of credits to be provided.

(6) Compensatory mitigation requirements (e.g., resource type and amount to be provided as compensatory mitigation, site protection, ecological performance standards, monitoring requirements) may be addressed through conditions added to the NWP authorization, instead of components of a compensatory mitigation plan (see 33 CFR 332.4(c)(1)(ii)).

(g) Compensatory mitigation will not be used to increase the acreage losses allowed by the acreage limits of the NWPs. For example, if an NWP has an acreage limit of 1/2-acre, it cannot be used to authorize any NWP activity resulting in the loss of greater than 1/2-acre of waters of the United States, even if compensatory mitigation is provided that replaces or restores some of the lost waters. However, compensatory mitigation can and should be used, as necessary, to ensure that an NWP activity already meeting the established acreage limits also satisfies the no more than minimal impact requirement for the NWPs.

(h) Permittees may propose the use of mitigation banks, in-lieu fee programs, or permittee-responsible mitigation. When developing a compensatory mitigation proposal, the permittee must consider appropriate and practicable options consistent with the framework at 33 CFR 332.3(b). For activities resulting in the loss of marine or estuarine resources, permittee-responsible mitigation may be environmentally preferable if there are no mitigation banks or in-lieu fee programs in the area that have marine or estuarine credits available for sale or transfer to the permittee. For permittee-responsible mitigation, the special conditions of the NWP verification must clearly indicate the party or parties responsible for the implementation and performance of the compensatory mitigation project, and, if required, its long-term management.

(i) Where certain functions and services of waters of the United States are permanently adversely affected by a regulated activity, such as discharges of dredged or fill

material into waters of the United States that will convert a forested or scrub-shrub wetland to a herbaceous wetland in a permanently maintained utility line right-of-way, mitigation may be required to reduce the adverse environmental effects of the activity to the no more than minimal level.

24. Safety of Impoundment Structures. To ensure that all impoundment structures are safely designed, the district engineer may require non-Federal applicants to demonstrate that the structures comply with established state dam safety criteria or have been designed by qualified persons. The district engineer may also require documentation that the design has been independently reviewed by similarly qualified persons, and appropriate modifications made to ensure safety.

25. Water Quality. Where States and authorized Tribes, or EPA where applicable, have not previously certified compliance of an NWP with CWA section 401, individual 401 Water Quality Certification must be obtained or waived (see 33 CFR 330.4(c)). The district engineer or State or Tribe may require additional water quality management measures to ensure that the authorized activity does not result in more than minimal degradation of water quality.

26. Coastal Zone Management. In coastal states where an NWP has not previously received a state coastal zone management consistency concurrence, an individual state coastal zone management consistency concurrence must be obtained, or a presumption of concurrence must occur (see 33 CFR 330.4(d)). The district engineer or a State may require additional measures to ensure that the authorized activity is consistent with state coastal zone management requirements.

27. Regional and Case-By-Case Conditions. The activity must comply with any regional conditions that may have been added by the Division Engineer (see 33 CFR 330.4(e)) and with any case specific conditions added by the Corps or by the state, Indian Tribe, or U.S. EPA in its section 401 Water Quality Certification, or by the state in its Coastal Zone Management Act consistency determination.

28. Use of Multiple Nationwide Permits. The use of more than one NWP for a single and complete project is prohibited, except when the acreage loss of waters of the United States authorized by the NWPs does not exceed the acreage limit of the NWP with the highest specified acreage limit. For example, if a road crossing over tidal waters is constructed under NWP 14, with associated bank stabilization authorized by NWP 13, the maximum acreage loss of waters of the United States for the total project cannot exceed 1/3-acre.

29. Transfer of Nationwide Permit Verifications. If the permittee sells the property associated with a nationwide permit verification, the permittee may transfer the nationwide permit verification to the new owner by submitting a letter to the appropriate Corps district office to validate the transfer. A copy of the nationwide permit verification must be attached to the letter, and the letter must contain the following statement and signature:
“When the structures or work authorized by this nationwide permit are still in existence at the time the property is transferred, the terms and conditions of this nationwide permit, including any special conditions, will continue to be binding on the new owner(s) of the property. To

validate the transfer of this nationwide permit and the associated liabilities associated with compliance with its terms and conditions, have the transferee sign and date below.”

(Transferee)

(Date)

30. Compliance Certification. Each permittee who receives an NWP verification letter from the Corps must provide a signed certification documenting completion of the authorized activity and implementation of any required compensatory mitigation. The success of any required permittee-responsible mitigation, including the achievement of ecological performance standards, will be addressed separately by the district engineer. The Corps will provide the permittee the certification document with the NWP verification letter. The certification document will include:

(a) A statement that the authorized activity was done in accordance with the NWP authorization, including any general, regional, or activity-specific conditions;

(b) A statement that the implementation of any required compensatory mitigation was completed in accordance with the permit conditions. If credits from a mitigation bank or in-lieu fee program are used to satisfy the compensatory mitigation requirements, the certification must include the documentation required by 33 CFR 332.3(l)(3) to confirm that the permittee secured the appropriate number and resource type of credits; and

(c) The signature of the permittee certifying the completion of the activity and mitigation.

The completed certification document must be submitted to the district engineer within 30 days of completion of the authorized activity or the implementation of any required compensatory mitigation, whichever occurs later.

31. Activities Affecting Structures or Works Built by the United States. If an NWP activity also requires permission from the Corps pursuant to 33 U.S.C. 408 because it will alter or temporarily or permanently occupy or use a U.S. Army Corps of Engineers (USACE) federally authorized Civil Works project (a “USACE project”), the prospective permittee must submit a pre-construction notification. See paragraph (b)(10) of general condition 32. An activity that requires section 408 permission is not authorized by NWP until the appropriate Corps office issues the section 408 permission to alter, occupy, or use the USACE project, and the district engineer issues a written NWP verification.

32. Pre-Construction Notification. (a) Timing. Where required by the terms of the NWP, the prospective permittee must notify the district engineer by submitting a pre-construction notification (PCN) as early as possible. The district engineer must determine if the PCN is complete within 30 calendar days of the date of receipt and, if the PCN is determined to be incomplete, notify the prospective permittee within that 30 day period to request the additional information necessary to make the PCN complete. The request must specify the information needed to make the PCN complete. As a general rule, district engineers will request additional information necessary to make the PCN complete only once. However, if the

prospective permittee does not provide all of the requested information, then the district engineer will notify the prospective permittee that the PCN is still incomplete and the PCN review process will not commence until all of the requested information has been received by the district engineer. The prospective permittee shall not begin the activity until either:

(1) He or she is notified in writing by the district engineer that the activity may proceed under the NWP with any special conditions imposed by the district or division engineer; or

(2) 45 calendar days have passed from the district engineer's receipt of the complete PCN and the prospective permittee has not received written notice from the district or division engineer. However, if the permittee was required to notify the Corps pursuant to general condition 18 that listed species or critical habitat might be affected or are in the vicinity of the activity, or to notify the Corps pursuant to general condition 20 that the activity might have the potential to cause effects to historic properties, the permittee cannot begin the activity until receiving written notification from the Corps that there is "no effect" on listed species or "no potential to cause effects" on historic properties, or that any consultation required under Section 7 of the Endangered Species Act (see 33 CFR 330.4(f)) and/or section 106 of the National Historic Preservation Act (see 33 CFR 330.4(g)) has been completed. Also, work cannot begin under NWPs 21, 49, or 50 until the permittee has received written approval from the Corps. If the proposed activity requires a written waiver to exceed specified limits of an NWP, the permittee may not begin the activity until the district engineer issues the waiver. If the district or division engineer notifies the permittee in writing that an individual permit is required within 45 calendar days of receipt of a complete PCN, the permittee cannot begin the activity until an individual permit has been obtained. Subsequently, the permittee's right to proceed under the NWP may be modified, suspended, or revoked only in accordance with the procedure set forth in 33 CFR 330.5(d)(2).

(b) Contents of Pre-Construction Notification: The PCN must be in writing and include the following information:

(1) Name, address and telephone numbers of the prospective permittee;

(2) Location of the proposed activity;

(3) Identify the specific NWP or NWP(s) the prospective permittee wants to use to authorize the proposed activity;

(4) A description of the proposed activity; the activity's purpose; direct and indirect adverse environmental effects the activity would cause, including the anticipated amount of loss of wetlands, other special aquatic sites, and other waters expected to result from the NWP activity, in acres, linear feet, or other appropriate unit of measure; a description of any proposed mitigation measures intended to reduce the adverse environmental effects caused by the proposed activity; and any other NWP(s), regional general permit(s), or individual permit(s) used or intended to be used to authorize any part of the proposed project or any related activity, including other separate and distant crossings for linear projects that require Department of the Army authorization but do not require pre-construction notification. The description of the proposed activity and any proposed mitigation measures should be sufficiently detailed to allow the district engineer to determine that the adverse environmental effects of the activity will be no more than minimal and to determine the need for compensatory mitigation or other mitigation measures. For single and complete linear projects, the PCN must include the quantity of anticipated losses of wetlands, other special aquatic sites, and other waters for each single and complete crossing of those wetlands, other special aquatic sites, and other waters.

Sketches should be provided when necessary to show that the activity complies with the terms of the NWP. (Sketches usually clarify the activity and when provided results in a quicker decision. Sketches should contain sufficient detail to provide an illustrative description of the proposed activity (e.g., a conceptual plan), but do not need to be detailed engineering plans);

(5) The PCN must include a delineation of wetlands, other special aquatic sites, and other waters, such as lakes and ponds, and perennial, intermittent, and ephemeral streams, on the project site. Wetland delineations must be prepared in accordance with the current method required by the Corps. The permittee may ask the Corps to delineate the special aquatic sites and other waters on the project site, but there may be a delay if the Corps does the delineation, especially if the project site is large or contains many wetlands, other special aquatic sites, and other waters. Furthermore, the 45 day period will not start until the delineation has been submitted to or completed by the Corps, as appropriate;

(6) If the proposed activity will result in the loss of greater than 1/10-acre of wetlands and a PCN is required, the prospective permittee must submit a statement describing how the mitigation requirement will be satisfied, or explaining why the adverse environmental effects are no more than minimal and why compensatory mitigation should not be required. As an alternative, the prospective permittee may submit a conceptual or detailed mitigation plan.

(7) For non-Federal permittees, if any listed species or designated critical habitat might be affected or is in the vicinity of the activity, or if the activity is located in designated critical habitat, the PCN must include the name(s) of those endangered or threatened species that might be affected by the proposed activity or utilize the designated critical habitat that might be affected by the proposed activity. For NWP activities that require pre-construction notification, Federal permittees must provide documentation demonstrating compliance with the Endangered Species Act;

(8) For non-Federal permittees, if the NWP activity might have the potential to cause effects to a historic property listed on, determined to be eligible for listing on, or potentially eligible for listing on, the National Register of Historic Places, the PCN must state which historic property might have the potential to be affected by the proposed activity or include a vicinity map indicating the location of the historic property. For NWP activities that require pre-construction notification, Federal permittees must provide documentation demonstrating compliance with section 106 of the National Historic Preservation Act;

(9) For an activity that will occur in a component of the National Wild and Scenic River System, or in a river officially designated by Congress as a “study river” for possible inclusion in the system while the river is in an official study status, the PCN must identify the Wild and Scenic River or the “study river” (see general condition 16); and

(10) For an activity that requires permission from the Corps pursuant to 33 U.S.C. 408 because it will alter or temporarily or permanently occupy or use a U.S. Army Corps of Engineers federally authorized civil works project, the pre-construction notification must include a statement confirming that the project proponent has submitted a written request for section 408 permission from the Corps office having jurisdiction over that USACE project.

(c) Form of Pre-Construction Notification: The standard individual permit application form (Form ENG 4345) may be used, but the completed application form must clearly indicate that it is an NWP PCN and must include all of the applicable information required in paragraphs (b)(1) through (10) of this general condition. A letter containing the required information may also be used. Applicants may provide electronic files of PCNs and

supporting materials if the district engineer has established tools and procedures for electronic submittals.

(d) Agency Coordination: (1) The district engineer will consider any comments from Federal and state agencies concerning the proposed activity's compliance with the terms and conditions of the NWPs and the need for mitigation to reduce the activity's adverse environmental effects so that they are no more than minimal.

(2) Agency coordination is required for: (i) all NWP activities that require pre-construction notification and result in the loss of greater than 1/2-acre of waters of the United States; (ii) NWP 21, 29, 39, 40, 42, 43, 44, 50, 51, and 52 activities that require pre-construction notification and will result in the loss of greater than 300 linear feet of stream bed; (iii) NWP 13 activities in excess of 500 linear feet, fills greater than one cubic yard per running foot, or involve discharges of dredged or fill material into special aquatic sites; and (iv) NWP 54 activities in excess of 500 linear feet, or that extend into the waterbody more than 30 feet from the mean low water line in tidal waters or the ordinary high water mark in the Great Lakes.

(3) When agency coordination is required, the district engineer will immediately provide (e.g., via e-mail, facsimile transmission, overnight mail, or other expeditious manner) a copy of the complete PCN to the appropriate Federal or state offices (FWS, state natural resource or water quality agency, EPA, and, if appropriate, the NMFS). With the exception of NWP 37, these agencies will have 10 calendar days from the date the material is transmitted to notify the district engineer via telephone, facsimile transmission, or e-mail that they intend to provide substantive, site-specific comments. The comments must explain why the agency believes the adverse environmental effects will be more than minimal. If so contacted by an agency, the district engineer will wait an additional 15 calendar days before making a decision on the pre-construction notification. The district engineer will fully consider agency comments received within the specified time frame concerning the proposed activity's compliance with the terms and conditions of the NWPs, including the need for mitigation to ensure the net adverse environmental effects of the proposed activity are no more than minimal. The district engineer will provide no response to the resource agency, except as provided below. The district engineer will indicate in the administrative record associated with each pre-construction notification that the resource agencies' concerns were considered. For NWP 37, the emergency watershed protection and rehabilitation activity may proceed immediately in cases where there is an unacceptable hazard to life or a significant loss of property or economic hardship will occur. The district engineer will consider any comments received to decide whether the NWP 37 authorization should be modified, suspended, or revoked in accordance with the procedures at 33 CFR 330.5.

(4) In cases of where the prospective permittee is not a Federal agency, the district engineer will provide a response to NMFS within 30 calendar days of receipt of any Essential Fish Habitat conservation recommendations, as required by section 305(b)(4)(B) of the Magnuson-Stevens Fishery Conservation and Management Act.

(5) Applicants are encouraged to provide the Corps with either electronic files or multiple copies of pre-construction notifications to expedite agency coordination.

DISTRICT ENGINEER'S DECISION

1. In reviewing the PCN for the proposed activity, the district engineer will determine whether the activity authorized by the NWP will result in more than minimal

individual or cumulative adverse environmental effects or may be contrary to the public interest. If a project proponent requests authorization by a specific NWP, the district engineer should issue the NWP verification for that activity if it meets the terms and conditions of that NWP, unless he or she determines, after considering mitigation, that the proposed activity will result in more than minimal individual and cumulative adverse effects on the aquatic environment and other aspects of the public interest and exercises discretionary authority to require an individual permit for the proposed activity. For a linear project, this determination will include an evaluation of the individual crossings of waters of the United States to determine whether they individually satisfy the terms and conditions of the NWP(s), as well as the cumulative effects caused by all of the crossings authorized by NWP. If an applicant requests a waiver of the 300 linear foot limit on impacts to streams or of an otherwise applicable limit, as provided for in NWPs 13, 21, 29, 36, 39, 40, 42, 43, 44, 50, 51, 52, or 54, the district engineer will only grant the waiver upon a written determination that the NWP activity will result in only minimal individual and cumulative adverse environmental effects. For those NWPs that have a waivable 300 linear foot limit for losses of intermittent and ephemeral stream bed and a 1/2-acre limit (i.e., NWPs 21, 29, 39, 40, 42, 43, 44, 50, 51, and 52), the loss of intermittent and ephemeral stream bed, plus any other losses of jurisdictional waters and wetlands, cannot exceed 1/2-acre.

2. When making minimal adverse environmental effects determinations the district engineer will consider the direct and indirect effects caused by the NWP activity. He or she will also consider the cumulative adverse environmental effects caused by activities authorized by NWP and whether those cumulative adverse environmental effects are no more than minimal. The district engineer will also consider site specific factors, such as the environmental setting in the vicinity of the NWP activity, the type of resource that will be affected by the NWP activity, the functions provided by the aquatic resources that will be affected by the NWP activity, the degree or magnitude to which the aquatic resources perform those functions, the extent that aquatic resource functions will be lost as a result of the NWP activity (e.g., partial or complete loss), the duration of the adverse effects (temporary or permanent), the importance of the aquatic resource functions to the region (e.g., watershed or ecoregion), and mitigation required by the district engineer. If an appropriate functional or condition assessment method is available and practicable to use, that assessment method may be used by the district engineer to assist in the minimal adverse environmental effects determination. The district engineer may add case-specific special conditions to the NWP authorization to address site-specific environmental concerns.

3. If the proposed activity requires a PCN and will result in a loss of greater than 1/10-acre of wetlands, the prospective permittee should submit a mitigation proposal with the PCN. Applicants may also propose compensatory mitigation for NWP activities with smaller impacts, or for impacts to other types of waters (e.g., streams). The district engineer will consider any proposed compensatory mitigation or other mitigation measures the applicant has included in the proposal in determining whether the net adverse environmental effects of the proposed activity are no more than minimal. The compensatory mitigation proposal may be either conceptual or detailed. If the district engineer determines that the activity complies with the terms and conditions of the NWP and that the adverse environmental effects are no more than minimal, after considering mitigation, the district engineer will notify the permittee and

include any activity-specific conditions in the NWP verification the district engineer deems necessary. Conditions for compensatory mitigation requirements must comply with the appropriate provisions at 33 CFR 332.3(k). The district engineer must approve the final mitigation plan before the permittee commences work in waters of the United States, unless the district engineer determines that prior approval of the final mitigation plan is not practicable or not necessary to ensure timely completion of the required compensatory mitigation. If the prospective permittee elects to submit a compensatory mitigation plan with the PCN, the district engineer will expeditiously review the proposed compensatory mitigation plan. The district engineer must review the proposed compensatory mitigation plan within 45 calendar days of receiving a complete PCN and determine whether the proposed mitigation would ensure the NWP activity results in no more than minimal adverse environmental effects. If the net adverse environmental effects of the NWP activity (after consideration of the mitigation proposal) are determined by the district engineer to be no more than minimal, the district engineer will provide a timely written response to the applicant. The response will state that the NWP activity can proceed under the terms and conditions of the NWP, including any activity-specific conditions added to the NWP authorization by the district engineer.

4. If the district engineer determines that the adverse environmental effects of the proposed activity are more than minimal, then the district engineer will notify the applicant either: (a) that the activity does not qualify for authorization under the NWP and instruct the applicant on the procedures to seek authorization under an individual permit; (b) that the activity is authorized under the NWP subject to the applicant's submission of a mitigation plan that would reduce the adverse environmental effects so that they are no more than minimal; or (c) that the activity is authorized under the NWP with specific modifications or conditions. Where the district engineer determines that mitigation is required to ensure no more than minimal adverse environmental effects, the activity will be authorized within the 45-day PCN period (unless additional time is required to comply with general conditions 18, 20, and/or 31, or to evaluate PCNs for activities authorized by NWPs 21, 49, and 50), with activity-specific conditions that state the mitigation requirements. The authorization will include the necessary conceptual or detailed mitigation plan or a requirement that the applicant submit a mitigation plan that would reduce the adverse environmental effects so that they are no more than minimal. When compensatory mitigation is required, no work in waters of the United States may occur until the district engineer has approved a specific mitigation plan or has determined that prior approval of a final mitigation plan is not practicable or not necessary to ensure timely completion of the required compensatory mitigation.

FURTHER INFORMATION

1. District Engineers have authority to determine if an activity complies with the terms and conditions of an NWP.
2. NWPs do not obviate the need to obtain other federal, state, or local permits, approvals, or authorizations required by law.
3. NWPs do not grant any property rights or exclusive privileges.
4. NWPs do not authorize any injury to the property or rights of others.
5. NWPs do not authorize interference with any existing or proposed Federal project (see general condition 31).

DEFINITIONS

Best management practices (BMPs): Policies, practices, procedures, or structures implemented to mitigate the adverse environmental effects on surface water quality resulting from development. BMPs are categorized as structural or non-structural.

Compensatory mitigation: The restoration (re-establishment or rehabilitation), establishment (creation), enhancement, and/or in certain circumstances preservation of aquatic resources for the purposes of offsetting unavoidable adverse impacts which remain after all appropriate and practicable avoidance and minimization has been achieved.

Currently serviceable: Useable as is or with some maintenance, but not so degraded as to essentially require reconstruction.

Direct effects: Effects that are caused by the activity and occur at the same time and place.

Discharge: The term “discharge” means any discharge of dredged or fill material into waters of the United States.

Ecological reference: A model used to plan and design an aquatic habitat and riparian area restoration, enhancement, or establishment activity under NWP 27. An ecological reference may be based on the structure, functions, and dynamics of an aquatic habitat type or a riparian area type that currently exists in the region where the proposed NWP 27 activity is located. Alternatively, an ecological reference may be based on a conceptual model for the aquatic habitat type or riparian area type to be restored, enhanced, or established as a result of the proposed NWP 27 activity. An ecological reference takes into account the range of variation of the aquatic habitat type or riparian area type in the region.

Enhancement: The manipulation of the physical, chemical, or biological characteristics of an aquatic resource to heighten, intensify, or improve a specific aquatic resource function(s). Enhancement results in the gain of selected aquatic resource function(s), but may also lead to a decline in other aquatic resource function(s). Enhancement does not result in a gain in aquatic resource area.

Ephemeral stream: An ephemeral stream has flowing water only during, and for a short duration after, precipitation events in a typical year. Ephemeral stream beds are located above the water table year-round. Groundwater is not a source of water for the stream. Runoff from rainfall is the primary source of water for stream flow.

Establishment (creation): The manipulation of the physical, chemical, or biological characteristics present to develop an aquatic resource that did not previously exist at an upland site. Establishment results in a gain in aquatic resource area.

High Tide Line: The line of intersection of the land with the water’s surface at the maximum height reached by a rising tide. The high tide line may be determined, in the absence of actual data, by a line of oil or scum along shore objects, a more or less continuous deposit of fine shell or debris on the foreshore or berm, other physical markings or characteristics, vegetation lines, tidal gages, or other suitable means that delineate the general height reached by a rising tide. The line encompasses spring high tides and other high tides that occur with periodic frequency but does not include storm surges in which there is a departure from the normal or predicted reach of the tide due to the piling up of water against a coast by strong winds such as those accompanying a hurricane or other intense storm.

Historic Property: Any prehistoric or historic district, site (including archaeological site), building, structure, or other object included in, or eligible for inclusion in, the National

Register of Historic Places maintained by the Secretary of the Interior. This term includes artifacts, records, and remains that are related to and located within such properties. The term includes properties of traditional religious and cultural importance to an Indian tribe or Native Hawaiian organization and that meet the National Register criteria (36 CFR part 60).

Independent utility: A test to determine what constitutes a single and complete non-linear project in the Corps Regulatory Program. A project is considered to have independent utility if it would be constructed absent the construction of other projects in the project area. Portions of a multi-phase project that depend upon other phases of the project do not have independent utility. Phases of a project that would be constructed even if the other phases were not built can be considered as separate single and complete projects with independent utility.

Indirect effects: Effects that are caused by the activity and are later in time or farther removed in distance, but are still reasonably foreseeable.

Intermittent stream: An intermittent stream has flowing water during certain times of the year, when groundwater provides water for stream flow. During dry periods, intermittent streams may not have flowing water. Runoff from rainfall is a supplemental source of water for stream flow.

Loss of waters of the United States: Waters of the United States that are permanently adversely affected by filling, flooding, excavation, or drainage because of the regulated activity. Permanent adverse effects include permanent discharges of dredged or fill material that change an aquatic area to dry land, increase the bottom elevation of a waterbody, or change the use of a waterbody. The acreage of loss of waters of the United States is a threshold measurement of the impact to jurisdictional waters for determining whether a project may qualify for an NWP; it is not a net threshold that is calculated after considering compensatory mitigation that may be used to offset losses of aquatic functions and services. The loss of stream bed includes the acres or linear feet of stream bed that are filled or excavated as a result of the regulated activity. Waters of the United States temporarily filled, flooded, excavated, or drained, but restored to pre-construction contours and elevations after construction, are not included in the measurement of loss of waters of the United States. Impacts resulting from activities that do not require Department of the Army authorization, such as activities eligible for exemptions under section 404(f) of the Clean Water Act, are not considered when calculating the loss of waters of the United States.

Navigable waters: Waters subject to section 10 of the Rivers and Harbors Act of 1899. These waters are defined at 33 CFR part 329.

Non-tidal wetland: A non-tidal wetland is a wetland that is not subject to the ebb and flow of tidal waters. Non-tidal wetlands contiguous to tidal waters are located landward of the high tide line (i.e., spring high tide line).

Open water: For purposes of the NWPs, an open water is any area that in a year with normal patterns of precipitation has water flowing or standing above ground to the extent that an ordinary high water mark can be determined. Aquatic vegetation within the area of flowing or standing water is either non-emergent, sparse, or absent. Vegetated shallows are considered to be open waters. Examples of "open waters" include rivers, streams, lakes, and ponds.

Ordinary High Water Mark: An ordinary high water mark is a line on the shore established by the fluctuations of water and indicated by physical characteristics, or by other appropriate means that consider the characteristics of the surrounding areas.

Perennial stream: A perennial stream has flowing water year-round during a typical year. The water table is located above the stream bed for most of the year. Groundwater is the

primary source of water for stream flow. Runoff from rainfall is a supplemental source of water for stream flow.

Practicable: Available and capable of being done after taking into consideration cost, existing technology, and logistics in light of overall project purposes.

Pre-construction notification: A request submitted by the project proponent to the Corps for confirmation that a particular activity is authorized by nationwide permit. The request may be a permit application, letter, or similar document that includes information about the proposed work and its anticipated environmental effects. Pre-construction notification may be required by the terms and conditions of a nationwide permit, or by regional conditions. A pre-construction notification may be voluntarily submitted in cases where pre-construction notification is not required and the project proponent wants confirmation that the activity is authorized by nationwide permit.

Preservation: The removal of a threat to, or preventing the decline of, aquatic resources by an action in or near those aquatic resources. This term includes activities commonly associated with the protection and maintenance of aquatic resources through the implementation of appropriate legal and physical mechanisms. Preservation does not result in a gain of aquatic resource area or functions.

Protected tribal resources: Those natural resources and properties of traditional or customary religious or cultural importance, either on or off Indian lands, retained by, or reserved by or for, Indian tribes through treaties, statutes, judicial decisions, or executive orders, including tribal trust resources.

Re-establishment: The manipulation of the physical, chemical, or biological characteristics of a site with the goal of returning natural/historic functions to a former aquatic resource. Re-establishment results in rebuilding a former aquatic resource and results in a gain in aquatic resource area and functions.

Rehabilitation: The manipulation of the physical, chemical, or biological characteristics of a site with the goal of repairing natural/historic functions to a degraded aquatic resource. Rehabilitation results in a gain in aquatic resource function, but does not result in a gain in aquatic resource area.

Restoration: The manipulation of the physical, chemical, or biological characteristics of a site with the goal of returning natural/historic functions to a former or degraded aquatic resource. For the purpose of tracking net gains in aquatic resource area, restoration is divided into two categories: re-establishment and rehabilitation.

Riffle and pool complex: Riffle and pool complexes are special aquatic sites under the 404(b)(1) Guidelines. Riffle and pool complexes sometimes characterize steep gradient sections of streams. Such stream sections are recognizable by their hydraulic characteristics. The rapid movement of water over a coarse substrate in riffles results in a rough flow, a turbulent surface, and high dissolved oxygen levels in the water. Pools are deeper areas associated with riffles. A slower stream velocity, a streaming flow, a smooth surface, and a finer substrate characterize pools.

Riparian areas: Riparian areas are lands next to streams, lakes, and estuarine- marine shorelines. Riparian areas are transitional between terrestrial and aquatic ecosystems, through which surface and subsurface hydrology connects riverine, lacustrine, estuarine, and marine waters with their adjacent wetlands, non-wetland waters, or uplands. Riparian areas provide a variety of ecological functions and services and help improve or maintain local water quality. (See general condition 23.)

Shellfish seeding: The placement of shellfish seed and/or suitable substrate to increase shellfish production. Shellfish seed consists of immature individual shellfish or individual shellfish attached to shells or shell fragments (i.e., spat on shell). Suitable substrate may consist of shellfish shells, shell fragments, or other appropriate materials placed into waters for shellfish habitat.

Single and complete linear project: A linear project is a project constructed for the purpose of getting people, goods, or services from a point of origin to a terminal point, which often involves multiple crossings of one or more waterbodies at separate and distant locations. The term “single and complete project” is defined as that portion of the total linear project proposed or accomplished by one owner/developer or partnership or other association of owners/developers that includes all crossings of a single water of the United States (i.e., a single waterbody) at a specific location. For linear projects crossing a single or multiple waterbodies several times at separate and distant locations, each crossing is considered a single and complete project for purposes of NWP authorization. However, individual channels in a braided stream or river, or individual arms of a large, irregularly shaped wetland or lake, etc., are not separate waterbodies, and crossings of such features cannot be considered separately.

Single and complete non-linear project: For non-linear projects, the term “single and complete project” is defined at 33 CFR 330.2(i) as the total project proposed or accomplished by one owner/developer or partnership or other association of owners/developers. A single and complete non-linear project must have independent utility (see definition of “independent utility”). Single and complete non-linear projects may not be “piecemealed” to avoid the limits in an NWP authorization.

Stormwater management: Stormwater management is the mechanism for controlling stormwater runoff for the purposes of reducing downstream erosion, water quality degradation, and flooding and mitigating the adverse effects of changes in land use on the aquatic environment.

Stormwater management facilities: Stormwater management facilities are those facilities, including but not limited to, stormwater retention and detention ponds and best management practices, which retain water for a period of time to control runoff and/or improve the quality (i.e., by reducing the concentration of nutrients, sediments, hazardous substances and other pollutants) of stormwater runoff.

Stream bed: The substrate of the stream channel between the ordinary high water marks. The substrate may be bedrock or inorganic particles that range in size from clay to boulders. Wetlands contiguous to the stream bed, but outside of the ordinary high water marks, are not considered part of the stream bed.

Stream channelization: The manipulation of a stream’s course, condition, capacity, or location that causes more than minimal interruption of normal stream processes. A channelized stream remains a water of the United States.

Structure: An object that is arranged in a definite pattern of organization. Examples of structures include, without limitation, any pier, boat dock, boat ramp, wharf, dolphin, weir, boom, breakwater, bulkhead, revetment, riprap, jetty, artificial island, artificial reef, permanent mooring structure, power transmission line, permanently moored floating vessel, piling, aid to navigation, or any other manmade obstacle or obstruction.

Tidal wetland: A tidal wetland is a jurisdictional wetland that is inundated by tidal waters. Tidal waters rise and fall in a predictable and measurable rhythm or cycle due to the gravitational pulls of the moon and sun. Tidal waters end where the rise and fall of the water

surface can no longer be practically measured in a predictable rhythm due to masking by other waters, wind, or other effects. Tidal wetlands are located channelward of the high tide line.

Tribal lands: Any lands title to which is either: 1) held in trust by the United States for the benefit of any Indian tribe or individual; or 2) held by any Indian tribe or individual subject to restrictions by the United States against alienation.

Tribal rights: Those rights legally accruing to a tribe or tribes by virtue of inherent sovereign authority, unextinguished aboriginal title, treaty, statute, judicial decisions, executive order or agreement, and that give rise to legally enforceable remedies.

Vegetated shallows: Vegetated shallows are special aquatic sites under the 404(b)(1) Guidelines. They are areas that are permanently inundated and under normal circumstances have rooted aquatic vegetation, such as seagrasses in marine and estuarine systems and a variety of vascular rooted plants in freshwater systems.

Waterbody: For purposes of the NWPs, a waterbody is a jurisdictional water of the United States. If a wetland is adjacent to a waterbody determined to be a water of the United States, that waterbody and any adjacent wetlands are considered together as a single aquatic unit (see 33 CFR 328.4(c)(2)). Examples of “waterbodies” include streams, rivers, lakes, ponds, and wetlands.

FINAL REGIONAL CONDITIONS 2017

NOTICE ABOUT WEB LINKS IN THIS DOCUMENT:

The web links (both internal to our Wilmington District and any external links to collaborating agencies) in this document are valid at the time of publication. However, the Wilmington District Regulatory Program web page addresses, as with other agency web sites, may change over the timeframe of the five-year Nationwide Permit renewal cycle, in response to policy mandates or technology advances. While we will make every effort to check on the integrity of our web links and provide re-direct pages whenever possible, we ask that you report any broken links to us so we can keep the page information current and usable. We apologize in advanced for any broken links that you may encounter, and we ask that you navigate from the Regulatory home page (Regulatory Permit Program Wetlands and Streams) of the Wilmington District Corps of Engineers, to the “Permits” section of our web site to find links for pages that cannot be found by clicking directly on the listed web link in this document.

Final 2017 Regional Conditions for Nationwide Permits (NWP) in the Wilmington District

1.0 Excluded Waters

The Corps has identified waters that will be excluded from the use of all NWP’s during certain timeframes. These waters are:

1.1 Anadromous Fish Spawning Areas

Waters of the United States identified by either the North Carolina Division of Marine Fisheries (NCDMF) or the North Carolina Wildlife Resources Commission (NCWRC) as anadromous fish spawning areas are excluded during the period between February 15 and June 30, without prior written approval from the Corps and either NCDMF or NCWRC.

1.2 Trout Waters Moratorium

Waters of the United States in the designated trout watersheds of North Carolina are excluded during the period between October 15 and April 15 without prior written approval from the NCWRC, or from the Eastern Band of Cherokee Indians (EBCI) Fisheries and Wildlife Management (FWM) office if the project is located on EBCI trust land. (See Section 2.7 for information on the designated trout watersheds).

1.3 Sturgeon Spawning Areas as Designated by the National Marine Fisheries Service (NMFS)

Waters of the United States designated as sturgeon spawning areas are excluded during the period between February 1 and June 30, without prior written approval from the NMFS.

2.0 Waters Requiring Additional Notification

The Corps has identified waters that will be subject to additional notification requirements for activities authorized by all NWPs. These waters are:

2.1 Western NC Counties that Drain to Designated Critical Habitat

For proposed activities within waters of the United States that require a Pre-Construction Notification (PCN) and are located in the sixteen counties listed below, permittees must provide a copy of the PCN to the U.S. Fish and Wildlife Service (USFWS), 160 Zillicoa Street, Asheville, North Carolina 28801. This PCN must be sent concurrently to the U.S. Fish and Wildlife Service and the Corps Asheville Regulatory Field Office. Please see General Condition 18 for specific notification requirements related to the Endangered Species Act and the below website for information on the location of designated critical habitat.

Counties with tributaries that drain to designated critical habitat that require notification to the Asheville U.S. Fish and Wildlife Service: Avery, Cherokee, Forsyth, Graham, Haywood, Henderson, Jackson, Macon, Mecklenburg, Mitchell, Stokes, Surry, Swain, Transylvania, Union and Yancey.

Website and office addresses for Endangered Species Act Information:

The Wilmington District has developed the following website for permittees which provides guidelines on how to review linked websites and maps in order to fulfill NWP General Condition 18 requirements:

<http://www.saw.usace.army.mil/Missions/RegulatoryPermitProgram/AgencyCoordination/ESA.asp>

Permittees who do not have internet access may contact the appropriate U.S. Fish and Wildlife Service offices listed below or Corps at (910) 251-4633:

Asheville U.S. Fish and Wildlife Service Office counties: All counties west of and including Anson, Stanly, Davidson, Forsythe and Stokes Counties.

U.S. Fish and Wildlife Service
Asheville Field Office
160 Zillicoa Street
Asheville, NC 28801
Telephone: (828) 258-3939

Raleigh U.S. Fish and Wildlife Service Office counties: all counties east of and including Richmond, Montgomery, Randolph, Guilford, and Rockingham Counties.

U.S. Fish and Wildlife Service
Raleigh Field Office
Post Office Box 33726

Raleigh, NC 27636-3726
Telephone: (919) 856-4520

2.2 Special Designation Waters

Prior to the use of any NWP, except NWP 3, that involves a discharge of dredged or fill material in any of the following identified waters and/or adjacent wetlands in North Carolina, permittees shall submit a PCN to the District Engineer prior to commencing the activity (see General Condition 32). The North Carolina waters and wetlands that require additional notification requirements are:

“Outstanding Resource Waters” (ORW) or “High Quality Waters” (HQW) as designated by the North Carolina Environmental Management Commission; “Primary Nursery Areas” (PNA), including inland PNA, as designated by the North Carolina Marine Fisheries Commission and the NCWRC; or wetlands adjacent to these waters. Definitions of ORW, HQW and PNA waters can be found in the North Carolina State Administrative Code, Title 15A, Subchapters 2B and 10C (15A NCAC 02B, 15A NCAC 10C) and at the following World Wide Web page: <http://reports.oah.state.nc.us/ncac.asp?folderName=\Title%2015A%20-%20Environmental%20Quality&lookupError=15A%20NCAC%20000%20>. Surface water classifications for waters in North Carolina can be viewed at the North Carolina Division of Water Resources website or at the following World Wide Web Page: <https://deq.nc.gov/about/divisions/water-resources/planning/classification-standards/classifications>

Permittees who do not have internet access may contact the Corps at (910) 251- 4633.

2.3 Coastal Area Management Act (CAMA) Areas of Environmental Concern

Non-federal permittees for any NWP in a designated “Area of Environmental Concern” (AEC) in the twenty (20) counties of Eastern North Carolina covered by the North Carolina Coastal Area Management Act (CAMA) must also obtain the required CAMA permit. Development activities for non-federal projects may not commence until a copy of the approved CAMA permit is furnished to the appropriate Wilmington District Regulatory Field Office (Wilmington Field Office – 69 Darlington Avenue, Wilmington, NC 28403, (910) 251-4802 or Washington Field Office – 2407 West 5th Street, Washington, NC 27889, (910) 251-4610).

2.4 Barrier Islands

Prior to the use of any NWP on a barrier island of North Carolina, permittees must submit a PCN to the District Engineer prior to commencing the activity (see General Condition 32).

2.5 Mountain or Piedmont Bogs

Prior to the use of any NWP in a Bog, as classified by the North Carolina Wetland Assessment Methodology (NCWAM), permittees shall submit a PCN to the District Engineer prior to commencing the activity (see General Condition 32). The latest version of NCWAM can be

viewed on the Corps RIBITS (Regulatory In-lieu Fee and Bank Information Tracking System) website or at the following World Wide Web Page:
https://ribits.usace.army.mil/ribits_apex/f?p=107:27:0::NO::

2.6 Animal Waste Facilities

Prior to use of any NWP for construction of animal waste facilities in waters of the United States, including wetlands, permittees shall submit a PCN to the District Engineer prior to commencing the activity (see General Condition 32).

2.7 Trout Waters

Prior to any discharge of dredge or fill material into streams, waterbodies or wetlands within the 294 designated trout watersheds of North Carolina, the permittee shall submit a PCN (see General Condition 32) to the District Engineer prior to commencing the activity, unless other thresholds are established in the Regional Conditions in Section 4 (Additional Regional Conditions for Specific Nationwide Permits). The permittee shall also provide a copy of the notification to the appropriate NCWRC office, or to the EBCI FWM Office (if the project is located on EBCI trust land), to facilitate the determination of any potential impacts to designated Trout Waters.

Notification to the Corps will include a statement with the name of the NCWRC or EBCI FWM biologist contacted, the date of the notification, the location of work, a delineation of wetlands and waters, a discussion of alternatives to working in the mountain trout waters, why alternatives were not selected, and, if applicable, a plan to provide compensatory mitigation for all unavoidable adverse impacts to mountain trout waters.

NCWRC and NC Trout Watersheds:

NCWRC Contact**	Counties that are entirely within Trout Watersheds*	Counties that are partially within Trout Watersheds*
Mountain Coordinator Balsam Depot 20830 Great Smoky Mountain Expressway Waynesville, NC 28786 Telephone: (828) 558-6011 For NCDOT Projects: NCDOT Coordinator 206 Charter. Street Albemarle, NC 28001 Telephone: (704) 982-9181	Alleghany Jackson Ashe Macon Avery Swain Graham Transylvania Haywood Watauga	Burke McDowell Buncombe Mitchell Caldwell Polk Cherokee Rutherford Clay Surry Henderson Wilkes Madison Yancey

*NOTE: To determine notification requirements, contact the Corps Asheville Regulatory Field Office at (828) 271-7980 or view maps for each County at the following World Wide Web page: <http://www.saw.usace.army.mil/Missions/Regulatory-Permit-Program/Agency-Coordination/Trout/>.

**If a project is located on EBCI trust land, submit the PCN in accordance with Section 3.14. Contact the Corps Asheville Regulatory Field Office at (828) 271-7980 with questions.

2.8 Western NC Waters and Corridors

The permittee shall submit a PCN (see General Condition 32) to the District Engineer prior to commencing the activity in waters of the United States if the activity will occur within any of the following identified waters in western North Carolina, within 0.5 mile on either side of these waters, or within 0.75 mile of the Little Tennessee River, as measured from the top of the bank of the respective water (i.e., river, stream, or creek):

Brasstown Creek
Burningtown Creek
Cane River
Caney Fork
Cartoogechaye Creek
Chattooga River
Cheoah River
Cowee Creek
Cullasaja River
Deep Creek
Ellijay Creek
French Broad River
Garden Creek
Hiwassee River
Hominy Creek
Iotla Creek
Little Tennessee River (within the river or within 0.75 mile on either side of this river)
Nantahala River
Nolichucky River
North Fork French Broad River
North Toe River
Nottley River
Oconaluftee River (portion not located on trust/EBCI land)
Peachtree Creek
Shooting Creek
Snowbird Creek
South Toe River
Stecoah Creek
Swannanoa River
Sweetwater Creek

Tuckasegee River (also spelled Tuckaseegee or Tuckaseigee)
Valley River
Watauga Creek
Watauga River
Wayah Creek
West Fork French Broad River

To determine notification requirements, contact the Corps Asheville Regulatory Field Office at (828) 271-7980 or view maps for all corridors at the following World Wide Web page:
<http://www.saw.usace.army.mil/Missions/Regulatory-Permit-Program/Agency-Coordination/Designated-Special-Waters.aspx>

3.0 List of Corps Regional Conditions for All Nationwide Permits

The following conditions apply to all Nationwide Permits in the Wilmington District:

3.1 Limitation of Loss of Stream Bed

NWPs may not be used for activities that may result in the loss or degradation of more than 300 total linear feet of stream bed, unless the District Engineer has waived the 300 linear foot limit for ephemeral and intermittent streams on a case-by-case basis and has determined that the proposed activity will result in minimal individual and cumulative adverse impacts to the aquatic environment. Waivers for the loss of ephemeral and intermittent streams must be in writing and documented by appropriate/accepted stream quality assessments*. This waiver only applies to the 300 linear feet threshold for NWPs.

This Regional Condition does not apply to NWP 23 (Approved Categorical Exclusions).

*NOTE: Permittees should utilize the most current methodology prescribed by Wilmington District to assess stream function and quality. Information can be found at:
https://ribits.usace.army.mil/ribits_apex/f?p=107:27:0::NO::

3.2 Mitigation for Loss of Stream Bed

For any NWP that results in a loss of more than 150 linear feet of stream, the permittee shall provide a mitigation proposal to compensate for more than minimal individual and cumulative adverse impacts to the aquatic environment. For stream losses of 150 linear feet or less that require a PCN, the District Engineer may determine, on a case-by-case basis, that compensatory mitigation is required to ensure that the activity results in minimal adverse effect on the aquatic environment.

3.3 Pre-construction Notification for Loss of Streambed Exceeding 150 Feet

Prior to use of any NWP for any activity which impacts more than 150 total linear feet of perennial stream, intermittent or ephemeral stream, the permittee shall submit a PCN to the District Engineer prior to commencing the activity (see General Condition 32). This applies to

NWPs that do not have specific notification requirements. If a NWP has specific notification requirements, the requirements of the NWP should be followed.

3.4 Restriction on Use of Live Concrete

For all NWPs which allow the use of concrete as a building material, live or fresh concrete, including bags of uncured concrete, may not come into contact with the water in or entering into waters of the United States. Water inside coffer dams or casings that has been in contact with wet concrete shall only be returned to waters of the United States after the concrete is set and cured and when it no longer poses a threat to aquatic organisms.

3.5 Requirements for Using Riprap for Bank Stabilization

For all NWPs that allow for the use of riprap material for bank stabilization, the following measures shall be applied:

3.5.1. Where bank stabilization is conducted as part of an activity, natural design, bioengineering and/or geoen지니어ing methods that incorporate natural durable materials, native seed mixes, and native plants and shrubs are to be utilized to the maximum extent practicable.

3.5.2. Filter cloth must be placed underneath the riprap as an additional requirement of its use in North Carolina waters. The placement of filter fabric is not required if the riprap will be pushed or “keyed” into the bank of the waterbody. A waiver from the specifications in this Regional Condition may be requested in writing. The waiver will only be issued if it can be demonstrated that the impacts of complying with this Regional Condition would result in greater adverse impacts to the aquatic environment.

3.5.3. The placement of riprap shall be limited to the areas depicted on submitted work plan drawings.

3.5.4. The riprap material shall be clean and free from loose dirt or any pollutant except in trace quantities that would not have an adverse environmental effect.

3.5.5. It shall be of a size sufficient to prevent its movement from the authorized alignment by natural forces under normal conditions.

3.5.6. The riprap material shall consist of clean rock or masonry material such as, but not limited to, granite, marl, or broken concrete.

3.6 Requirements for Culvert Placement

3.6.1 For all NWPs that involve the construction/installation of culverts, measures will be included in the construction/installation that will promote the safe passage of fish and other aquatic organisms. The dimension, pattern, and profile of the stream above and below a pipe or culvert should not be modified by altering the width or depth of the stream profile in connection with the construction activity. The width, height, and gradient of a proposed culvert should be

sufficient to pass the average historical low flow and spring flow without adversely altering flow velocity. Spring flow is the seasonal sustained high flow that typically occurs in the spring. Spring flows should be determined from gage data, if available. In the absence of such data, bank-full flow can be used as a comparable indicator.

In Public Trust Areas of Environmental Concern (AEC) and/or the Estuarine Waters AEC as designated by the Coastal Area Management Act (CAMA): All pipes/culverts must be sufficiently sized to allow for the burial of the bottom of the culvert at least one foot below normal bed elevation.



In all other areas: Culverts greater than 48 inches in diameter will be buried at least one foot below the bed of the stream. Culverts 48 inches in diameter or less shall be buried to maintain aquatic passage and to maintain passage during drought or low flow conditions, and every effort shall be made to maintain the existing channel slope.

Culverts must be designed and constructed in a manner that minimizes destabilization and head cutting. Destabilizing the channel and head cutting upstream should be considered and appropriate actions incorporated in the design and placement of the culvert.

A waiver from the depth specifications in this condition may be requested, in writing, by the permittee and issued by the Corp; this request must be specific as to the reason(s) for the request. The waiver will be issued if it can be demonstrated that the proposed design would result in less impacts to the aquatic environment.

All counties: Culverts placed within riparian and/or riverine wetlands must be installed in a manner that does not restrict the flow and circulation patterns of waters of the United States.

Culverts placed across wetland fills purely for the purposes of equalizing surface water do not have to be buried, but the culverts must be of adequate size and/or number to ensure unrestricted transmission of water.

3.6.2 Bank-full flows (or less) shall be accommodated through maintenance of the existing bank-full channel cross sectional area. Additional culverts or culvert barrels at such crossings shall be allowed only to receive bank-full flows.



3.6.3 Where adjacent floodplain is available, flows exceeding bank-full should be accommodated by installing culverts at the floodplain elevation. Additional culverts or culvert barrels at such crossings should not be buried, or if buried, must have sills at the inlets to ensure that they only receive flows exceeding bank-full.

3.6.4 Excavation of existing stream channels shall be limited to the minimum necessary to construct or install the proposed culvert. The final width of the impacted stream at the culvert inlet and outlet should be no greater than the original stream width. A waiver from this condition may be requested in writing; this request must be specific as to the reason(s) for the request. The waiver will be issued if the proposed design would result in less impacts to the aquatic environment and/or if it can be demonstrated that it is not practicable to restore the final width of the impacted stream at the culvert inlet and outlet to the width of the original stream channel.

3.6.5 The width of the culvert shall be comparable to the width of the stream channel. If the width of the culvert is wider than the stream channel, the culvert shall include baffles, benches and/or sills to maintain the width of the stream channel. A waiver from this condition may be requested in writing; this request must be specific as to the reason(s) for the request. The waiver will be issued if it can be demonstrated that it is not practicable or necessary to include baffles, benches or sills and the design would result in less impacts to the aquatic environment.

3.7 Notification to NCDEQ Shellfish Sanitation Section

Permittees shall notify the NCDEQ Shellfish Sanitation Section prior to dredging in or removing sediment from an area closed to shell fishing where the effluent may be released to an area open for shell fishing or swimming in order to avoid contamination from the disposal area and cause a temporary shellfish closure to be made. Such notification shall also be provided to the appropriate Corps Regulatory Field Office. Any disposal of sand to the ocean beach should occur between November 1 and April 30 when recreational usage is low. Only clean sand

should be used and no dredged sand from closed shell fishing areas may be used. If beach disposal were to occur at times other than stated above or if sand from a closed shell fishing area is to be used, a swimming advisory shall be posted, and a press release shall be issued by the permittee.

3.8 Submerged Aquatic Vegetation

Impacts to Submerged Aquatic Vegetation (SAV) are not authorized by any NWP, except NWP 48, unless EFH Consultation has been completed pursuant to the Magnuson-Stevens Fisheries Conservation and Management Act (Magnuson-Stevens Act). Permittees shall submit a PCN (See NWP General Condition 32) to the District Engineer prior to commencing the activity if the project would affect SAV. The permittee may not begin work until notified by the Corps that the requirements of the Magnuson-Stevens Act have been satisfied and that the activity is authorized.

3.9 Sedimentation and Erosion Control Structures and Measures

All PCNs will identify and describe sedimentation and erosion control structures and measures proposed for placement in waters of the United States. The structures and measures should be depicted on maps, surveys or drawings showing location and impacts to jurisdictional wetlands and streams.

3.10 Restoration of Temporary Impacts to Stream Beds

Upon completion of work that involves temporary stream impacts, streambeds are to be restored to pre-project elevations and widths using natural streambed material such that the impacted stream reach mimics the adjacent upstream and downstream reach. The impacted area shall be backfilled with natural streambed material to a depth of at least 12 inches or to the bottom depth of the impacted area if shallower than 12 inches. An engineered in-stream structure or material can be used to provide protection of a buried structure if it provides benefits to the aquatic environment and can be accomplished by a natural streambed design. A permittee may request a waiver of this condition if it is determined a buried structure needs significant physical protection beyond those provided in this condition. This condition does not apply to NWP 27 – Aquatic Habitat Restoration, Enhancement, and Establishment Activities.

3.11 Restoration of Temporary Impacts to Stream Banks

Upon completion of work involving temporary stream bank impacts, stream banks are to be restored to pre-project grade and contours or beneficial grade and contours if the original bank slope is steep and unstable. Natural durable materials, native seed mixes, and native plants and shrubs are to be utilized in the restoration. Natural designs which use bioengineered and/or geo-engineered methods are to be applied. An engineered structure or material can be used to provide protection of a buried structure if it provides benefits to the stream bank environment, provided it is not in excess of the minimum amount needed for protection and does not exceed an average of one cubic yard per running foot placed along the bank below the plane of the ordinary high water mark. A permittee may request a waiver of this condition if it is determined a buried structure

needs significant physical protection beyond those provided in this condition. This condition does not apply to NWP 27 – Aquatic Habitat Restoration, Enhancement, and Establishment Activities.

3.12 Federal Navigation Channel Setbacks and Corps Easements

3.12.1 Authorized structures and fills located in or adjacent to Federally authorized waterways will be constructed in accordance with the latest setback criteria established by the Wilmington District Engineer. You may review the setback policy at <http://www.saw.usace.army.mil/Missions/Navigation/Setbacks.aspx>. This general permit does not authorize the construction of hardened or permanently fixed structures within the Federally Authorized Channel Setback, unless the activity is approved by the Corps. The permittee shall submit a PCN (see General Condition 32) to the District Engineer prior to the construction of any structures or fills within the Federally Authorized Channel Setback.

3.12.2 The permittee shall obtain a Consent to Cross Government Easement from the Wilmington District’s Land Use Coordinator prior to any crossing of the Corps easement and/or prior to commencing construction of any structures, authorized dredging or other work within the right-of-way of, or in proximity to, a federally designated disposal area. The Land Use Coordinator may be contacted at: CESAW-OP-N, 69 Darlington Avenue, Wilmington, North Carolina 28403-1343, email: SAWWeb-NAV@usace.army.mil

3.13 Northern Long-eared Bat – Endangered Species Act Compliance

The Wilmington District, U.S. Army Corps of Engineers has consulted with the United States Fish and Wildlife Service (USFWS) in regards to the threatened Northern long-eared bat (NLEB) (*Myotis septentrionalis*) and Standard Local Operating Procedures for Endangered Species (SLOPES) have been approved by the Corps and the USFWS. This condition concerns effects to the NLEB only and does not address effects to other federally listed species and/or federally designated critical habitat.

A. Procedures when the Corps is the lead federal* agency for a project:

The permittee must comply with (1) and (2) below when:

- the project is located in the western 41 counties of North Carolina, to include non-federal aid North Carolina Department of Transportation (NCDOT) projects, OR;
- the project is located in the 59 eastern counties of North Carolina, and is a non-NCDOT project.

*Generally, if a project is located on private property or on non-federal land, and the project is not being funded by a federal entity, the Corps will be the lead federal agency due to the requirement to obtain Department of the Army authorization to impact waters of the United States. If the project is located on federal land, contact the Corps to determine the lead federal agency.

(1) A permittee using a NWP must check to see if their project is located in the range of the NLEB by using the following website:

<http://www.fws.gov/midwest/endangered/mammals/nleb/pdf/WNSZone.pdf>. If the project is within the range of the NLEB, or if the project includes percussive activities (e.g., blasting, pile driving, etc.), the permittee is then required to check the appropriate website in the paragraph below to discover if their project:

- is located in a 12-digit Hydrologic Unit Code area (“red HUC” - shown as red areas on the map), AND/OR;
- involves percussive activities within 0.25 mile of a red HUC.

Red HUC maps - for the western 41 counties in NC (covered by the Asheville Ecological Services Field Office), check the project location against the electronic maps found at: http://www.fws.gov/asheville/htmls/project_review/NLEB_in_WNC.html. For the eastern 59 counties in NC (covered by the Raleigh Ecological Services Field Office), check the project location against the electronic maps found at:

https://www.fws.gov/raleigh/NLEB_RFO.html.

(2) A permittee must submit a PCN to the District Engineer, and receive written authorization from the District Engineer, prior to commencing the activity, if the activity will involve any of the following:

- tree clearing/removal, construction/installation of wind turbines in a red HUC, AND/OR;
- bridge removal or maintenance, unless the bridge has been inspected and there is no evidence of bat use, (applies anywhere in the range of the NLEB), AND/OR;
- percussive activities in a red HUC, or within 0.25 mile of a red HUC.

The permittee may proceed with the activity without submitting a PCN to either the Corps or the USFWS, provided the activity complies with all applicable NWP terms and general and regional conditions, if the permittee’s review under A.(1) and A.(2) above shows that the project is:

- located outside of a red HUC (and there are no percussive activities), and the activity will NOT include bridge removal or maintenance, unless the bridge has been inspected and there is no evidence of bat use, OR;
- located outside of a red HUC and there are percussive activities, but the percussive activities will not occur within 0.25-mile of a red HUC boundary, and the activity will NOT include bridge removal or maintenance, unless the bridge has been inspected and there is no evidence of bat use, OR;

- located in a red HUC, but the activity will NOT include: tree clearing/removal; construction/installation of wind turbines; bridge removal or maintenance, unless the bridge has been inspected and there is no evidence of bat use, and/or; any percussive activities.

B. Procedures when the USACE is not the lead federal agency:

For projects where another federal agency is the lead federal agency - if that other federal agency has completed project-specific ESA Section 7(a)(2) consultation for the NLEB, and has (1) determined that the project would not cause prohibited incidental take of the NLEB, and (2) completed coordination/consultation that is required by the USFWS (per the directions on the respective USFWS office's website), that project may proceed without notification to either the USACE or the USFWS, provided all General and Regional Permit Conditions are met.

The NLEB SLOPES can be viewed on the USACE website at the following World Wide Web Page: <http://www.saw.usace.army.mil/Missions/Regulatory-Permit-Program/Agency-Coordination/ESA/>. Permittees who do not have internet access may contact the USACE at (910) 251- 4633.

3.14 Work on Eastern Band of Cherokee Indians Land

All PCNs submitted for activities in waters of the United States on Eastern Band of Cherokee Indians (EBCI) trust land (i.e., Qualla Boundary and non-contiguous tracts of trust land), must comply with the requirements of the latest MOU between the Wilmington District and the Eastern Band of Cherokee Indians.

4.0 Additional Regional Conditions for Specific Nationwide Permits

4.1 NWP #14 - Linear Transportation Projects

4.1.1 If appropriate, permittees shall employ natural channel design (see definition below and NOTE below) to the maximum extent practicable for stream relocations. All stream relocation proposals shall include a Relocation and Monitoring Plan and a functional assessment of baseline conditions (e.g., use of the North Carolina Stream Assessment Methodology). Compensatory mitigation may be required for stream relocations.

Natural Channel Design means a geomorphologic approach to stream restoration based on an understanding of valley type, general watershed conditions, dimension, pattern, profile, hydrology and sediment transport of natural, stable channels (reference condition) and applying this understanding to the reconstruction of a stable channel.

NOTE: For more information on Natural Channel Design, permittees should reference North Carolina Stream Mitigation Guidance on the Corps RIBITS (Regulatory In-lieu Fee and Bank Information Tracking System) website or at the following World Wide Web Page: https://ribits.usace.army.mil/ribits_apex/f?p=107:27:16705499703550::NO:RP:P27_BUTTON_KEY:0.

4.1.2 This NWP authorizes only upland to upland crossings and cannot be used in combination with Nationwide Permit 18 to create an upland within waters of the United States, including wetlands.

4.1.3 This NWP cannot be used for private projects located in tidal waters or tidal wetlands.

4.1.4 In designated trout watersheds, a PCN is not required for impacts to a maximum of 60 linear feet (150 linear feet for temporary dewatering) or 1/10-acre of jurisdictional aquatic resources for proposed structures not adjoining, adjacent to, or connected to existing structures. In designated trout waters, the permittee shall submit a PCN (see Regional Conditions 2.7 and General Condition 32) to the District Engineer prior to commencing the activity if 1) impacts (other than temporary dewatering to work in dry conditions) to jurisdictional aquatic resources exceed 60 linear feet or 1/10-acre; 2) temporary impacts to streams or waterbodies associated with dewatering to work in dry conditions exceed 150 linear feet; 3) the project will involve impacts to wetlands; 4) the primary purpose of the project is for commercial development; 5) the project involves the replacement of a bridge or spanning structure with a culvert or non-spanning structure in waters of the United States; or 6) the activity will be constructed during the trout waters moratorium (October 15 through April 15).

4.1.5 The permittee shall submit a PCN to the District Engineer prior to commencing the activity if the activity will involve the discharge of dredged or fill material into more than 150 linear feet of stream channel for the construction of temporary access fills and/or temporary road crossings. The PCN must include a restoration plan that thoroughly describes how all temporary fills will be removed, describes how pre-project conditions will be restored, and includes a timetable for all restoration activities.

STATE OF NORTH CAROLINA
DEPARTMENT OF ENVIRONMENTAL QUALITY
DIVISION OF WATER RESOURCES

WATER QUALITY GENERAL CERTIFICATION NO. 4088

GENERAL CERTIFICATION FOR PROJECTS ELIGIBLE FOR US ARMY CORPS OF ENGINEERS

- **NATIONWIDE PERMIT NUMBER 14 (LINEAR TRANSPORTATION PROJECTS), AND**
- **REGIONAL GENERAL PERMIT 198200031 (NCDOT BRIDGES, WIDENING PROJECTS, INTERCHANGE IMPROVEMENTS)**

Water Quality Certification Number 4088 is issued in conformity with the requirements of Section 401, Public Laws 92-500 and 95-217 of the United States and subject to the North Carolina Regulations in 15A NCAC 02H .0500 and 15A NCAC 02B .0200 for the discharge of fill material to surface waters and wetland areas as described in 33 CFR 330 Appendix A (B) (14) of the US Army Corps of Engineers regulations and Regional General Permit 198200031.

The State of North Carolina certifies that the specified category of activity will not violate applicable portions of Sections 301, 302, 303, 306 and 307 of the Public Laws 92-500 and 95-217 if conducted in accordance with the conditions hereinafter set forth.

Effective date: March 19, 2017

Signed this day March 3, 2017

By

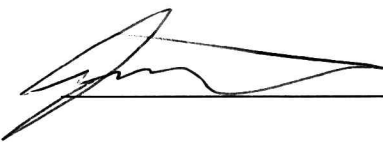

for S. Jay Zimmerman, P.G.
Director

GC4088

Activities meeting any one (1) of the following thresholds or circumstances require written approval for a 401 Water Quality Certification from the Division of Water Resources (DWR):

- a) If any of the conditions of this Certification (listed below) cannot be met; or
- b) Any temporary or permanent impacts to wetlands, open waters and/or streams, except for construction of a driveway to a single family residential lot that are not determined to be part of a larger common plan of development as long as the driveway involves *less than 25 feet* of total stream impacts, including any in-stream stabilization needed for the crossing; or
- c) Any stream relocation or stream restoration; or
- d) Any high density project, as defined in 15A NCAC 02H .1003(2)(a) and by the density thresholds specified in 15A NCAC 02H .1017, which does not have a stormwater management plan reviewed and approved under a state stormwater program¹ or a state-approved local government stormwater program². Projects that have vested rights, exemptions, or grandfathering from state or locally-implemented stormwater programs and projects that satisfy state or locally-implemented stormwater programs through use of community in-lieu programs **require written approval**; or
- e) Any impacts to waters, or to wetlands adjacent to waters, designated as: ORW (including SAV), HQW (including PNA), SA, WS-I, WS-II, Trout, or North Carolina or National Wild and Scenic River; or
- f) Any impacts to coastal wetlands [15A NCAC 07H .0205], or Unique Wetlands (UWL); or
- g) Any impact associated with a Notice of Violation or an enforcement action for violation(s) of NC Wetland Rules (15A NCAC 02H .0500), NC Isolated Wetland Rules (15A NCAC 02H .1300), NC Surface Water or Wetland Standards (15A NCAC 02B .0200), or State Regulated Riparian Buffer Rules (15A NCAC 02B .0200); or
- h) Any impacts to subject water bodies and/or state regulated riparian buffers along subject water bodies in the Neuse, Tar-Pamlico, or Catawba River Basins or in the Randleman Lake, Jordan Lake or Goose Creek Watersheds (or any other basin or watershed with State Regulated Riparian Area Protection Rules [Buffer Rules] in effect at the time of application) *unless*:
 - i) The activities are listed as “EXEMPT” from these rules; or
 - ii) A Buffer Authorization Certificate is issued by the NC Division of Coastal Management (DCM); or
 - iii) A Buffer Authorization Certificate or a Minor Variance is issued by a delegated or designated local government implementing a state riparian buffer program pursuant to 143-215.23

Activities included in this General Certification that do not meet one of the thresholds listed above do not require written approval.

¹ e.g. Coastal Counties, HQW, ORW, or state-implemented Phase II NPDES

² e.g. Delegated Phase II NPDES, Water Supply Watershed, Nutrient-Sensitive Waters, or Universal Stormwater Management Program

GC4088

I. ACTIVITY SPECIFIC CONDITIONS:

1. If this Water Quality Certification is used to access residential, commercial or industrial building sites, then all parcels owned by the applicant that are part of the single and complete project authorized by this Certification must be buildable without additional impacts to streams or wetlands. If required in writing by DWR, the applicant shall provide evidence that the parcels are buildable without requiring additional impacts to wetlands, waters, or state regulated riparian buffers. [15A NCAC 02H .0506(b)(4) and (c)(4)]
2. For road and driveway construction purposes, this Certification shall only be utilized from natural high ground to natural high ground. [15A NCAC 02H .0506(b)(2) and (c)(2)]
3. Deed notifications or similar mechanisms shall be placed on all lots with retained jurisdictional wetlands, waters, and state regulated riparian buffers within the project boundaries in order to assure compliance with NC Wetland Rules (15A NCAC 02H .0500), NC Isolated Wetland Rules (15A NCAC 02H .1300), and/or State Regulated Riparian Buffer Rules (15A NCAC 02B .0200). These mechanisms shall be put in place at the time of recording of the property or individual parcels, whichever is appropriate. [15A NCAC 02H .0506(b)(4) and (c)(4)]
4. For the North Carolina Department of Transportation, compliance with the NCDOT's individual NPDES permit NCS000250 shall serve to satisfy this condition. For all other projects that disturb one acre or more of land (including a project that disturbs less than one acre of land that is part of a larger common plan of development or sale); have permanent wetland, stream, or open water impacts; and are proposing new built-upon area shall comply with the following requirements: [15A NCAC 02H .0506(b)(5) and (c)(5)]
 - a. Stormwater management shall be provided throughout the entire project area in accordance with 15A NCAC 02H .1003. For the purposes of 15A NCAC 02H .1003(2)(a), density thresholds shall be determined in accordance with 15A NCAC 02H .1017.
 - b. Projects that have vested rights, exemptions, or grandfathering from state or locally-implemented stormwater programs do not satisfy this condition. Projects that satisfy state or locally-implemented stormwater programs through use of community in-lieu programs do not satisfy this condition.
 - c. Projects that require written authorization from DWR shall submit the following with their application for review and approval:
 - i. For projects that have a stormwater management plan (SMP) reviewed under a state stormwater program¹ or a state-approved local government stormwater program² shall submit plans that show the location and approximate size of all proposed stormwater measures;

¹ e.g. Coastal Counties, HQW, ORW, or state-implemented Phase II NPDES

² e.g. Delegated Phase II NPDES, Water Supply Watershed, Nutrient-Sensitive Waters, or Universal Stormwater Management Program

GC4088

- ii. All other low density projects not covered above shall submit a completed low density supplement form with all required items; and
 - iii. All other high density projects not covered above shall submit a completed SMP, including all appropriate stormwater control measure (SCM) supplemental forms and associated items, that complies with the high density development requirements of 15A NCAC 02H .1003.
- d. Projects that do not require written approval from DWR shall obtain approval of the SMP, when required, before any impacts authorized by this Certification occur.
- e. SMPs approved by DWR may be phased on a case-by-case basis. SMPs for each future phase must be approved before construction of that phase commences. Approved SMPs may not be modified without prior written authorization from DWR.

II. GENERAL CONDITIONS:

1. When written authorization is required, the plans and specifications for the project are incorporated into the authorization by reference and are an enforceable part of the Certification. Any modifications to the project require notification to DWR and may require an application submittal to DWR with the appropriate fee. [15A NCAC 02H .0501 and .0502]
2. No waste, spoil, solids, or fill of any kind shall occur in wetlands or waters beyond the footprint of the impacts (including temporary impacts) as authorized in the written approval from DWR; or beyond the thresholds established for use of this Certification without written authorization. [15A NCAC 02H .0501 and .0502]

No removal of vegetation or other impacts of any kind shall occur to state regulated riparian buffers beyond the footprint of impacts approved in a Buffer Authorization or Variance or as listed as an exempt activity in the applicable riparian buffer rules. [15A NCAC 02B .0200]

3. In accordance with 15A NCAC 02H .0506(h), compensatory mitigation may be required for losses of greater than 150 linear feet of streams and/or greater than one (1) acre of wetlands. Impacts to isolated and other non-404 jurisdictional wetlands shall not be combined with 404 jurisdictional wetlands for the purpose of determining when impact thresholds trigger a mitigation requirement. For linear publicly owned and maintained transportation projects that are not determined to be part of a larger common plan of development by the US Army Corps of Engineers, compensatory mitigation may be required for losses of greater than 150 linear feet per stream.

Compensatory stream and/or wetland mitigation shall be proposed and completed in compliance with G.S. 143-214.11. For applicants proposing to conduct mitigation within a project site, a complete mitigation proposal developed in accordance with the most recent guidance issued by the US Army Corps of Engineers Wilmington District shall be submitted for review and approval with the application for impacts.

GC4088

4. All activities shall be in compliance with any applicable State Regulated Riparian Buffer Rules in Chapter 2 of Title 15A.
5. When applicable, all construction activities shall be performed and maintained in full compliance with G.S. Chapter 113A Article 4 (Sediment and Pollution Control Act of 1973). Regardless of applicability of the Sediment and Pollution Control Act, all projects shall incorporate appropriate Best Management Practices for the control of sediment and erosion so that no violations of state water quality standards, statutes, or rules occur. [15A NCAC 02H .0506(b)(3) and (c)(3) and 15A NCAC 02B .0200]

Design, installation, operation, and maintenance of all sediment and erosion control measures shall be equal to or exceed the requirements specified in the most recent version of the *North Carolina Sediment and Erosion Control Manual*, or for linear transportation projects, the *NC DOT Sediment and Erosion Control Manual*.

All devices shall be maintained on all construction sites, borrow sites, and waste pile (spoil) sites, including contractor-owned or leased borrow pits associated with the project. Sufficient materials required for stabilization and/or repair of erosion control measures and stormwater routing and treatment shall be on site at all times.

For borrow pit sites, the erosion and sediment control measures shall be designed, installed, operated, and maintained in accordance with the most recent version of the *North Carolina Surface Mining Manual*. Reclamation measures and implementation shall comply with the reclamation in accordance with the requirements of the Sedimentation Pollution Control Act and the Mining Act of 1971.

If the project occurs in waters or watersheds classified as Primary Nursery Areas (PNAs), SA, WS-I, WS-II, High Quality Waters (HQW), or Outstanding Resource Waters (ORW), then the sedimentation and erosion control designs shall comply with the requirements set forth in 15A NCAC 04B .0124, *Design Standards in Sensitive Watersheds*.

6. Sediment and erosion control measures shall not be placed in wetlands or waters except within the footprint of temporary or permanent impacts authorized under this Certification. Exceptions to this condition require application to and written approval from DWR. [15A NCAC 02H .0501 and .0502]
7. Erosion control matting that incorporates plastic mesh and/or plastic twine shall not be used along streambanks or within wetlands. Exceptions to this condition require application to and written approval from DWR. [15A NCAC 02B .0201]

GC4088

8. An NPDES Construction Stormwater Permit (NCG010000) is required for construction projects that disturb one (1) or more acres of land. The NCG010000 Permit allows stormwater to be discharged during land disturbing construction activities as stipulated in the conditions of the permit. If the project is covered by this permit, full compliance with permit conditions including the erosion & sedimentation control plan, inspections and maintenance, self-monitoring, record keeping and reporting requirements is required. [15A NCAC 02H .0506(b)(5) and (c)(5)]

The North Carolina Department of Transportation (NCDOT) shall be required to be in full compliance with the conditions related to construction activities within the most recent version of their individual NPDES (NCS000250) stormwater permit. [15A NCAC 02H .0506(b)(5) and (c)(5)]

9. All work in or adjacent to streams shall be conducted so that the flowing stream does not come in contact with the disturbed area. Approved best management practices from the most current version of the *NC Sediment and Erosion Control Manual*, or the *NC DOT Construction and Maintenance Activities Manual*, such as sandbags, rock berms, cofferdams, and other diversion structures shall be used to minimize excavation in flowing water. Exceptions to this condition require application to and written approval from DWR. [15A NCAC 02H .0506(b)(3) and (c)(3)]
10. If activities must occur during periods of high biological activity (e.g. sea turtle nesting, fish spawning, or bird nesting), then biological monitoring may be required at the request of other state or federal agencies and coordinated with these activities. [15A NCAC 02H .0506 (b)(2) and 15A NCAC 04B .0125]

All moratoriums on construction activities established by the NC Wildlife Resources Commission (WRC), US Fish and Wildlife Service (USFWS), NC Division of Marine Fisheries (DMF), or National Marine Fisheries Service (NMFS) shall be implemented. Exceptions to this condition require written approval by the resource agency responsible for the given moratorium. A copy of the approval from the resource agency shall be forwarded to DWR.

Work within a designated trout watershed of North Carolina (as identified by the Wilmington District of the US Army Corps of Engineers), or identified state or federal endangered or threatened species habitat, shall be coordinated with the appropriate WRC, USFWS, NMFS, and/or DMF personnel.

11. Culverts shall be designed and installed in such a manner that the original stream profiles are not altered and allow for aquatic life movement during low flows. The dimension, pattern, and profile of the stream above and below a pipe or culvert shall not be modified by widening the stream channel or by reducing the depth of the stream in connection with the construction activity. The width, height, and gradient of a proposed culvert shall be such as to pass the average historical low flow and spring flow without adversely altering flow velocity. [15A NCAC 02H .0506(b)(2) and (c)(2)]

GC4088

Placement of culverts and other structures in streams shall be below the elevation of the streambed by one foot for all culverts with a diameter greater than 48 inches, and 20% of the culvert diameter for culverts having a diameter less than or equal to 48 inches, to allow low flow passage of water and aquatic life.

If multiple pipes or barrels are required, they shall be designed to mimic the existing stream cross section as closely as possible including pipes or barrels at flood plain elevation and/or sills where appropriate. Widening the stream channel shall be avoided.

When topographic constraints indicate culvert slopes of greater than 5%, culvert burial is not required, provided that all alternative options for flattening the slope have been investigated and aquatic life movement/connectivity has been provided when possible (e.g. rock ladders, cross vanes, etc.). Notification, including supporting documentation to include a location map of the culvert, culvert profile drawings, and slope calculations, shall be provided to DWR 60 calendar days prior to the installation of the culvert.

When bedrock is present in culvert locations, culvert burial is not required provided that there is sufficient documentation of the presence of bedrock. Notification, including supporting documentation such as, a location map of the culvert, geotechnical reports, photographs, etc. shall be provided to DWR a minimum of 60 calendar days prior to the installation of the culvert. If bedrock is discovered during construction, then DWR shall be notified by phone or email within 24 hours of discovery.

If other site-specific topographic constraints preclude the ability to bury the culverts as described above and/or it can be demonstrated that burying the culvert would result in destabilization of the channel, then exceptions to this condition require application to and written approval from DWR.

Installation of culverts in wetlands shall ensure continuity of water movement and be designed to adequately accommodate high water or flood conditions. When roadways, causeways, or other fill projects are constructed across FEMA-designated floodways or wetlands, openings such as culverts or bridges shall be provided to maintain the natural hydrology of the system as well as prevent constriction of the floodway that may result in destabilization of streams or wetlands.

The establishment of native woody vegetation and other soft stream bank stabilization techniques shall be used where practicable instead of rip-rap or other bank hardening methods.

12. Bridge deck drains shall not discharge directly into the stream. Stormwater shall be directed across the bridge and pre-treated through site-appropriate means to the maximum extent practicable (e.g. grassed swales, pre-formed scour holes, vegetated buffers, etc.) before entering the stream. Exceptions to this condition require application to and written approval from DWR. [15A NCAC 02H .0506(b)(5)]

GC4088

13. Application of fertilizer to establish planted/seeded vegetation within disturbed riparian areas and/or wetlands shall be conducted at agronomic rates and shall comply with all other Federal, State and Local regulations. Fertilizer application shall be accomplished in a manner that minimizes the risk of contact between the fertilizer and surface waters. [15A NCAC 02B .0200 and 15A NCAC 02B .0231]
14. If concrete is used during construction, then all necessary measures shall be taken to prevent direct contact between uncured or curing concrete and waters of the state. Water that inadvertently contacts uncured concrete shall not be discharged to waters of the state. [15A NCAC 02B .0200]
15. All proposed and approved temporary fill and culverts shall be removed and the impacted area shall be returned to natural conditions within 60 calendar days after the temporary impact is no longer necessary. The impacted areas shall be restored to original grade, including each stream's original cross sectional dimensions, planform pattern, and longitudinal bed profile. For projects that receive written approval, no temporary impacts are allowed beyond those included in the application and authorization. All temporarily impacted sites shall be restored and stabilized with native vegetation. [15A NCAC 02H .0506(b)(2) and (c)(2)]
16. All proposed and approved temporary pipes/culverts/rip-rap pads etc. in streams shall be installed as outlined in the most recent edition of the *North Carolina Sediment and Erosion Control Planning and Design Manual* or the *North Carolina Surface Mining Manual* or the *North Carolina Department of Transportation Best Management Practices for Construction and Maintenance Activities* so as not to restrict stream flow or cause dis-equilibrium during use of this Certification. [15A NCAC 02H .0506(b)(2) and (c)(2)]
17. Any rip-rap required for proper culvert placement, stream stabilization, or restoration of temporarily disturbed areas shall be restricted to the area directly impacted by the approved construction activity. All rip-rap shall be placed such that the original stream elevation and streambank contours are restored and maintained. Placement of rip-rap or other approved materials shall not result in de-stabilization of the stream bed or banks upstream or downstream of the area or in a manner that precludes aquatic life passage. [15A NCAC 02H .0506(b)(2)]
18. Any rip-rap used for stream or shoreline stabilization shall be of a size and density to prevent movement by wave, current action, or stream flows and shall consist of clean rock or masonry material free of debris or toxic pollutants. Rip-rap shall not be installed in the streambed except in specific areas required for velocity control and to ensure structural integrity of bank stabilization measures. [15A NCAC 02H .0506(b)(2)]
19. Applications for rip-rap groins proposed in accordance with 15A NCAC 07H .1401 (NC Division of Coastal Management General Permit for construction of Wooden and Rip-rap Groins in Estuarine and Public Trust Waters) shall meet all the specific conditions for design and construction specified in 15A NCAC 07H .1405.

GC4088

20. All mechanized equipment operated near surface waters shall be inspected and maintained regularly to prevent contamination of surface waters from fuels, lubricants, hydraulic fluids, or other toxic materials. Construction shall be staged in order to minimize the exposure of equipment to surface waters to the maximum extent practicable. Fueling, lubrication and general equipment maintenance shall not take place within 50 feet of a waterbody or wetlands to prevent contamination by fuels and oils. [15A NCAC 02H .0506(b)(3) and (c)(3) and 15A NCAC 02B .0211 (12)]
21. Heavy equipment working in wetlands shall be placed on mats or other measures shall be taken to minimize soil disturbance. [15A NCAC 02H .0506(b)(3) and (c)(3)]
22. In accordance with 143-215.85(b), the applicant shall report any petroleum spill of 25 gallons or more; any spill regardless of amount that causes a sheen on surface waters; any petroleum spill regardless of amount occurring within 100 feet of surface waters; and any petroleum spill less than 25 gallons that cannot be cleaned up within 24 hours.
23. If an environmental document is required under the State Environmental Policy Act (SEPA), then this General Certification is not valid until a Finding of No Significant Impact (FONSI) or Record of Decision (ROD) is issued by the State Clearinghouse. If an environmental document is required under the National Environmental Policy Act (NEPA), then this General Certification is not valid until a Categorical Exclusion, the Final Environmental Assessment, or Final Environmental Impact Statement is published by the lead agency. [15A NCAC 01C .0107(a)]
24. This General Certification does not relieve the applicant of the responsibility to obtain all other required Federal, State, or Local approvals before proceeding with the project, including those required by, but not limited to, Sediment and Erosion Control, Non-Discharge, Water Supply Watershed, and Trout Buffer regulations.
25. The applicant and their authorized agents shall conduct all activities in a manner consistent with State water quality standards (including any requirements resulting from compliance with §303(d) of the Clean Water Act), and any other appropriate requirements of State and Federal Law. If DWR determines that such standards or laws are not being met, including failure to sustain a designated or achieved use, or that State or Federal law is being violated, or that further conditions are necessary to assure compliance, then DWR may revoke or modify a written authorization associated with this General Water Quality Certification. [15A NCAC 02H .0507(d)]
26. When written authorization is required for use of this Certification, upon completion of all permitted impacts included within the approval and any subsequent modifications, the applicant shall be required to return a certificate of completion (available on the DWR website <https://edocs.deq.nc.gov/Forms/Certificate-of-Completion>). [15A NCAC 02H .0502(f)]

GC4088

27. Additional site-specific conditions, including monitoring and/or modeling requirements, may be added to the written approval letter for projects proposed under this Water Quality Certification in order to ensure compliance with all applicable water quality and effluent standards. [15A NCAC 02H .0507(c)]
28. If the property or project is sold or transferred, the new Permittee shall be given a copy of this Certification (and written authorization if applicable) and is responsible for complying with all conditions. [15A NCAC 02H .0501 and .0502]

III. GENERAL CERTIFICATION ADMINISTRATION:

1. In accordance with North Carolina General Statute 143-215.3D(e), written approval for a 401 Water Quality General Certification must include the appropriate fee. An applicant for a CAMA permit under Article 7 of Chapter 113A of the General Statutes for which a Water Quality Certification is required shall only make one payment to satisfy both agencies; the fee shall be as established by the Secretary in accordance with 143-215.3D(e)(7).
2. This Certification neither grants nor affirms any property right, license, or privilege in any waters, or any right of use in any waters. This Certification does not authorize any person to interfere with the riparian rights, littoral rights, or water use rights of any other person and this Certification does not create any prescriptive right or any right of priority regarding any usage of water. This Certification shall not be interposed as a defense in any action respecting the determination of riparian or littoral rights or other rights to water use. No consumptive user is deemed by virtue of this Certification to possess any prescriptive or other right of priority with respect to any other consumptive user regardless of the quantity of the withdrawal or the date on which the withdrawal was initiated or expanded.
3. This Certification grants permission to the Director, an authorized representative of the Director, or DWR staff, upon the presentation of proper credentials, to enter the property during normal business hours. [15A NCAC 02H .0502(e)]
4. This General Certification shall expire on the same day as the expiration date of the corresponding Nationwide Permit and/or Regional General Permit. The conditions in effect on the date of issuance of Certification for a specific project shall remain in effect for the life of the project, regardless of the expiration date of this Certification. This General Certification is rescinded when the US Army Corps of Engineers reauthorizes any of the corresponding Nationwide Permits and/or Regional General Permits or when deemed appropriate by the Director of the Division of Water Resources.
5. Non-compliance with or violation of the conditions herein set forth by a specific project may result in revocation of this General Certification for the project and may also result in criminal and/or civil penalties.

GC4088

6. The Director of the North Carolina Division of Water Resources may require submission of a formal application for Individual Certification for any project in this category of activity if it is determined that the project is likely to have a significant adverse effect upon water quality, including state or federally listed endangered or threatened aquatic species, or degrade the waters so that existing uses of the water or downstream waters are precluded.
7. Public hearings may be held prior to a Certification decision if deemed in the public's best interest by the Director of the North Carolina Division of Water Resources.

History Note: Water Quality Certification (WQC) Number 4088 issued March 3, 2017 replaces WQC 3886 issued March 12, 2012; WQC Number 3820 issued April 6, 2010; WQC Number 3627 issued March 2007; WQC Number 3404 issued March 2003; WQC Number 3375 issued March 18, 2002; WQC Number 3289 issued June 1, 2000; WQC Number 3103 issued February 11, 1997; WQC Number 2732 issued May 1, 1992; WQC Number 2666 issued January 21, 1992; WQC Number 2177 issued November 5, 1987.



ROY COOPER
Governor

MICHAEL S. REGAN
Secretary

LINDA CULPEPPER
Interim Director

November 20, 2017
Franklin County
NCDWR Project No. 20171421
Bridge 89 on SR 1001
State Project No. 17BP.5.R.68

APPROVAL of 401 WATER QUALITY CERTIFICATION and TAR-PAMLICO BUFFER AUTHORIZATION, with ADDITIONAL CONDITIONS

Mr. J.R. Hopkins, P.E., Division Engineer
NCDOT, Division 5
2612 North Duke Street
Durham, NC 27704

Dear Mr. Hopkins:

You have our approval, in accordance with the conditions listed below, for the following impacts for the purpose of replacing Bridge 89 in Franklin County:

Stream Impacts in the Tar-Pamlico River Basin

Site	Permanent Fill in Perennial Stream (linear ft)	Bank Stabilization to Perennial Stream (linear ft)	Temporary Impact to Perennial Stream (linear ft)	Total Stream Impact (linear ft)
1	0	108	91	199
2	109	0	15	124
Total	109	108	106	323

Total Stream Impact for Project: 323 linear feet.

Tar-Pamlico Riparian Buffer Impacts

Site	Zone 1 Impact (sq ft)	Zone 1 Buffer Mitigation Required (using 3:1 ratio)	Zone 2 Impact (sq ft)	Zone 2 Buffer Mitigation Required (using 1.5:1 ratio)
Bridge	2380	N/A	5	N/A
Road	7116	21348	5578	8367
Totals	9496	21348	5583	8367

* n/a = Bridge Impact Allowable; no mitigation required

Total Buffer Impact for Project: 15079 square feet.

The project shall be constructed in accordance with your application received November 3, 2017. After reviewing your application, we have decided that these impacts are covered by General Water Quality Certification Number 4088. This certification corresponds to the Nationwide Permit 14 issued by the Corps of Engineers. This approval is also valid for the Tar-Pamlico Riparian Buffer Rules (15A NCAC 2B.0259). In addition, you should acquire any other federal, state or local permits before you proceed with your project including (but not limited to) Sediment and Erosion Control, Non-Discharge and Water Supply Watershed regulations. This approval will expire with the accompanying 404 permit.

This approval is valid solely for the purpose and design described in your application (unless modified below). Should your project change, you must notify the NCDWR and submit a new application. If the property is sold, the new owner must be given a copy of this Certification and approval letter, and is thereby responsible for complying with all the conditions. If total wetland fills for this project (now or in the future) exceed one acre, or of total impacts to streams (now or in the future) exceed 150 linear feet, compensatory mitigation may be required as described in 15A NCAC 2H .0506 (h) (6) and (7). Additional buffer impacts may require compensatory mitigation as described in 15A NCAC 2B.0259. For this approval to remain valid, you must adhere to the conditions listed in the General Certifications and any additional conditions listed below.

Conditions of Certification:

1. Compensatory mitigation for impacts to 7116 square feet of protected riparian buffers in Zone 1 and 5578 square feet of protected riparian buffers in Zone 2 shall be required. We understand that you have chosen to perform compensatory mitigation for impacts to protected buffers through use of the North Carolina Division of Mitigation Services (DMS) (formerly NCEEP). Mitigation for unavoidable impacts to Tar-Pamlico Riparian Buffers shall be provided in the Tar-Pamlico River Basin and done in accordance with 15A NCAC .02B .0295. The DMS has indicated in a letter dated October 25, 2017 that they will assume responsibility for satisfying the compensatory mitigation requirements for the above-referenced project, in accordance with DMS's Mitigation Banking Instrument signed June 14, 2016.
2. The post-construction removal of any temporary bridge structures must return the project site to its preconstruction contours and elevations. The impacted areas shall be revegetated with appropriate native species. [15A NCAC 02H .0506(b)(2)]
3. As a condition of this 401 Water Quality Certification, the bridge demolition and construction must be accomplished in strict compliance with the most recent version of NCDOT's Best Management Practices for Construction and Maintenance Activities. [15A NCAC 02H .0507(d)(2) and 15A NCAC 02H .0506(b)(5)]
4. Bridge deck drains shall not discharge directly into the stream. Stormwater shall be directed across the bridge and pre-treated through site-appropriate means (grassed swales, pre-formed scour holes, vegetated buffers, etc.) before entering the stream. To meet the requirements of NCDOT's NPDES permit NCS0000250 [delete if non-DOT project], please refer to the most recent version of the *North Carolina Department of Transportation Stormwater Best Management Practices Toolbox* manual for approved measures. [15A NCAC 02H .0507(d)(2) and 15A NCAC 02H .0506(b)(5)]
5. All riparian buffers impacted by the placement of temporary fill or clearing activities shall be restored to the preconstruction contours and revegetated. Maintained buffers shall be permanently revegetated with non-woody species by the end of the growing season following completion of construction. For the purpose of this condition, maintained buffer areas are defined as areas within the transportation corridor that will be subject to regular NCDOT maintenance activities including mowing. The area with non-maintained buffers shall be permanently revegetated with native woody species before the next growing season following completion of construction. [15A NCAC 2B..0259]
6. Pursuant to 15A NCAC 2B.0259(6), sediment and erosion control devices shall not be placed in Zone 1 of any Tar-Pamlico Buffer without prior approval by the NCDWR. At this time, the NCDWR has approved no sediment and erosion control devices in Zone 1, outside of the approved project impacts, anywhere on this project. Moreover, sediment and erosion control devices shall be allowed in Zone 2 of the buffers provided that Zone 1 is not compromised and that discharge is released as diffuse flow.
7. All stormwater runoff shall be directed as sheetflow through stream buffers at non-erosive velocities, unless otherwise approved by this certification. [15A NCAC 2B..0259]
8. If concrete is used during construction, a dry work area shall be maintained to prevent direct contact between curing concrete and stream water. Water that inadvertently contacts uncured concrete shall not be discharged to surface waters due to the potential for elevated pH and possible aquatic life and fish kills. [15A NCAC 02B.0200]
9. During the construction of the project, no staging of equipment of any kind is permitted in waters of the U.S., or protected riparian buffers. [15A NCAC 02H.0506(b)(2)]
10. The dimension, pattern and profile of the stream above and below the crossing shall not be modified. Disturbed floodplains and streams shall be restored to natural geomorphic conditions. [15A NCAC 02H.0506(b)(2)]

11. The use of rip-rap above the Normal High Water Mark shall be minimized. Any rip-rap placed for stream stabilization shall be placed in stream channels in such a manner that it does not impede aquatic life passage. [15A NCAC 02H.0506(b)(2)]
12. The Permittee shall ensure that the final design drawings adhere to the permit and to the permit drawings submitted for approval. [15A NCAC 02H .0507 (c) and 15A NCAC 02H .0506 (b)(2) and (c)(2)]
13. All work in or adjacent to stream waters shall be conducted in a dry work area. Approved BMP measures from the most current version of NCDOT Construction and Maintenance Activities manual such as sandbags, rock berms, cofferdams and other diversion structures shall be used to prevent excavation in flowing water. [15A NCAC 02H.0506(b)(3) and (c)(3)]
14. Heavy equipment shall be operated from the banks rather than in the stream channel in order to minimize sedimentation and reduce the introduction of other pollutants into the stream. [15A NCAC 02H.0506(b)(3)]
15. All mechanized equipment operated near surface waters must be regularly inspected and maintained to prevent contamination of stream waters from fuels, lubricants, hydraulic fluids, or other toxic materials. [15A NCAC 02H.0506(b)(3)]
16. No rock, sand or other materials shall be dredged from the stream channel except where authorized by this certification. [15A NCAC 02H.0506(b)(3)]
17. Discharging hydroseed mixtures and washing out hydroseeders and other equipment in or adjacent to surface waters is prohibited. [15A NCAC 02H.0506(b)(3)]
18. The permittee and its authorized agents shall conduct its activities in a manner consistent with State water quality standards (including any requirements resulting from compliance with §303(d) of the Clean Water Act) and any other appropriate requirements of State and Federal law. If the NCDWR determines that such standards or laws are not being met (including the failure to sustain a designated or achieved use) or that State or federal law is being violated, or that further conditions are necessary to assure compliance, the NCDWR may reevaluate and modify this certification. [15A NCAC 02B.0200]
19. All fill slopes located in jurisdictional wetlands shall be placed at slopes no flatter than 3:1, unless otherwise authorized by this certification. [15A NCAC 02H.0506(b)(2)]
20. A copy of this Water Quality Certification shall be maintained on the construction site at all times. In addition, the Water Quality Certification and all subsequent modifications, if any, shall be maintained with the Division Engineer and the on-site project manager. [15A NCAC 02H .0507(c) and 15A NCAC 02H .0506 (b)(2) and (c)(2)]
21. The outside buffer, wetland or water boundary located within the construction corridor approved by this authorization, including all non-commercial borrow and waste sites associated with the project, shall be clearly marked by highly visible fencing prior to any land disturbing activities. Impacts to areas within the fencing are prohibited unless otherwise authorized by this certification. [15A NCAC 02H.0501 and .0502]
22. The issuance of this certification does not exempt the Permittee from complying with any and all statutes, rules, regulations, or ordinances that may be imposed by other government agencies (i.e. local, state, and federal) having jurisdiction, including but not limited to applicable buffer rules, stormwater management rules, soil erosion and sedimentation control requirements, etc.
23. The Permittee shall report any violations of this certification to the Division of Water Resources within 24 hours of discovery. [15A NCAC 02B.0506(b)(2)]
24. Upon completion of the project (including any impacts at associated borrow or waste sites), the NCDOT Division Engineer shall complete and return the enclosed "Certification of Completion Form" to notify the NCDWR when all work included in the 401 Certification has been completed. [15A NCAC 02H.0502(f)]
25. Native riparian vegetation (i.e., trees and shrubs native to your geographic region) must be reestablished in the riparian areas within the construction limits of the project by the end of the growing season following completion of construction. [15A NCAC 02B.0259(10)] & [15A NCAC 02B.0506(b)(2)]

26. There shall be no excavation from, or waste disposal into, jurisdictional wetlands or waters associated with this permit without appropriate modification. Should waste or borrow sites, or access roads to waste or borrow sites, be located in wetlands or streams, compensatory mitigation will be required since that is a direct impact from road construction activities. [15A NCAC 02H.0506(b)(3) and (c)(3)]

27. Erosion and sediment control practices must be in full compliance with all specifications governing the proper design, installation and operation and maintenance of such Best Management Practices in order to protect surface waters standards [15A NCAC 02H.0506(b)(3) and (c)(3)]:

- a. The erosion and sediment control measures for the project must be designed, installed, operated, and maintained in accordance with the most recent version of the *North Carolina Sediment and Erosion Control Planning and Design Manual*.
- b. The design, installation, operation, and maintenance of the sediment and erosion control measures must be such that they equal, or exceed, the requirements specified in the most recent version of the *North Carolina Sediment and Erosion Control Manual*. The devices shall be maintained on all construction sites, borrow sites, and waste pile (spoil) projects, including contractor-owned or leased borrow pits associated with the project.
- c. For borrow pit sites, the erosion and sediment control measures must be designed, installed, operated, and maintained in accordance with the most recent version of the *North Carolina Surface Mining Manual*.
- d. The reclamation measures and implementation must comply with the reclamation in accordance with the requirements of the Sedimentation Pollution Control Act.

28. Sediment and erosion control measures shall not be placed in wetlands or surface waters, or within 5 feet of the top of bank, without prior approval from DWR. [15A NCAC 02H.0506(b)(3) and (c)(3)]

29. Unless otherwise approved in this certification, placement of culverts and other structures in open waters and streams, shall be placed below the elevation of the streambed by one foot for all culverts with a diameter greater than 48 inches, and 20 percent of the culvert diameter for culverts having a diameter less than 48 inches, to allow low flow passage of water and aquatic life. Design and placement of culverts and other structures including temporary erosion control measures shall not be conducted in a manner that may result in dis-equilibrium of wetlands or streambeds or banks, adjacent to or upstream and down stream of the above structures. The applicant is required to provide evidence that the equilibrium is being maintained if requested in writing by the NCDWR. If this condition is unable to be met due to bedrock or other limiting features encountered during construction, please contact the NCDWR for guidance on how to proceed and to determine whether or not a permit modification will be required. [15A NCAC 02H.0506(b)(2)]

30. Riprap shall not be placed in the active thalweg channel or placed in the streambed in a manner that precludes aquatic life passage. Bioengineering boulders or structures should be properly designed, sized and installed. [15A NCAC 02H.0506(b)(2)]

31. For any streams being impacted due to site dewatering activities, the site shall be graded to its preconstruction contours and revegetated with appropriate native species. [15A NCAC 02H.0506(b)(2)]

32. The stream channel shall be excavated no deeper than the natural bed material of the stream, to the maximum extent practicable. Efforts must be made to minimize impacts to the stream banks, as well as to vegetation responsible for maintaining the stream bank stability. Any applicable riparian buffer impact for access to stream channel shall be temporary and be revegetated with native riparian species. [15A NCAC 02H.0506(b)(2)]

If you wish to contest any statement in the attached Certification you must file a petition for an administrative hearing. You may obtain the petition form from the office of Administrative hearings. You must file the petition with the office of Administrative Hearings within sixty (60) days of receipt of this notice. A petition is considered filed when it is received in the office of Administrative Hearings during normal office hours. The Office of Administrative Hearings accepts filings Monday through Friday between the hours of 8:00am and 5:00pm, except for official state holidays. The original and one (1) copy of the petition must be filed with the Office of Administrative Hearings.

The petition may be faxed-provided the original and one copy of the document is received by the Office of Administrative Hearings within five (5) business days following the faxed transmission.

The mailing address for the Office of Administrative Hearings is:

Office of Administrative Hearings
6714 Mail Service Center
Raleigh, NC 27699-6714
Telephone: (919) 431-3000, Facsimile: (919) 431-3100

A copy of the petition must also be served on DEQ as follows:

Mr. Sam M. Hayes, General Counsel
Department of Environmental Quality
1601 Mail Service Center

This letter completes the review of the Division of Water Resources under Section 401 of the Clean Water Act. If you have any questions, please contact Rob Ridings at 919-707-8786.

Sincerely,

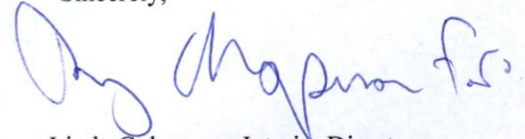
A handwritten signature in blue ink, appearing to read "Linda Culpepper".

Linda Culpepper, Interim Director
Division of Water Resources

Electronic copy only distribution:

Eric Alsmeyer, US Army Corps of Engineers, Raleigh Field Office
Chris Murray, Division 5 Environmental Officer
Beth Harmon, Division of Mitigation Services
File Copy



ROY COOPER
Governor

MICHAEL S. REGAN
Secretary

LINDA CULPEPPER
Interim Director

NCDWR Project No.: _____ County: _____

Applicant: _____

Project Name: _____

Date of Issuance of 401 Water Quality Certification: _____

Certificate of Completion

Upon completion of all work approved within the 401 Water Quality Certification or applicable Buffer Rules, and any subsequent modifications, the applicant is required to return this certificate to the 401 Transportation Permitting Unit, North Carolina Division of Water Resources, 1617 Mail Service Center, Raleigh, NC, 27699-1617. This form may be returned to NCDWR by the applicant, the applicant's authorized agent, or the project engineer. It is not necessary to send certificates from all of these.

Applicant's Certification

I, _____, hereby state that, to the best of my abilities, due care and diligence was used in the observation of the construction such that the construction was observed to be built within substantial compliance and intent of the 401 Water Quality Certification and Buffer Rules, the approved plans and specifications, and other supporting materials.

Signature: _____ Date: _____

Agent's Certification

I, _____, hereby state that, to the best of my abilities, due care and diligence was used in the observation of the construction such that the construction was observed to be built within substantial compliance and intent of the 401 Water Quality Certification and Buffer Rules, the approved plans and specifications, and other supporting materials.

Signature: _____ Date: _____

Engineer's Certification

_____ Partial _____ Final

I, _____, as a duly registered Professional Engineer in the State of North Carolina, having been authorized to observe (periodically, weekly, full time) the construction of the project for the Permittee hereby state that, to the best of my abilities, due care and diligence was used in the observation of the construction such that the construction was observed to be built within substantial compliance and intent of the 401 Water Quality Certification and Buffer Rules, the approved plans and specifications, and other supporting materials.

Signature _____ Registration No. _____

Date _____



Tue 12/19/2017 1:54 PM

Alsmeyer, Eric C CIV USARMY CESAW (US) <Eric.C.Alsmeier@usace.army.mil>

[External] NWP verification and NCDMS mitigation - NCDOT_17BP.4.R.84_BR89_SR1001_Pearces Rd; AID SAW-2016- 01617.

To Murray, Christopher A

Cc Harmon, Beth; Montague, Heather W; Hughes, Andrea W CIV USARMY CESAW (US); Browning, Kimberly D CIV USARMY CESAW (US)



Incorrect information on subject line. Project is actually 17BP.5.R.68. This issue was recognized by USACE email on 12/20/2017

CAUTION: External email. Do not click links or open attachments unless verified. Send all suspicious email as an attachment to [report.spam@usace.army.mil](#)

On 11/3/2017, the US Army Corps of Engineers, Wilmington District received your e-mail pre-construction notification (ePCN), for replacement of Bridge No. 89; NCDOT; Project No. ~~17BP.4.R.84~~ BR89; SR1001; Pearces Rd; AID SAW-2016- 01617; Franklin County, North Carolina. Your notification indicated that you will impact 69 linear feet of stream and 0.19 acre of wetlands.

Based on the information provided in your application, your work meets the terms and conditions of Nationwide Permits (NWPs) 14 - Linear Transportation Projects, and, since we did not act on your ePCN within 45 days, your project is statutorily authorized, provided it is accomplished in strict accordance with the attached conditions and your submitted description. Any violation of the attached conditions or deviation from your submitted description may subject the permittee to a stop work order, a restoration order and/or appropriate legal action. Attached is a copy of the NWPs 3 and 13 and the applicable permit conditions. If the nationwide permit authorization expires or is suspended, revoked, or is modified, such that the activity would no longer comply with the terms and conditions of the nationwide permit, activities which have commenced (i.e., are under construction) or are under contract to commence in reliance upon the nationwide permit, will remain authorized provided the activity is completed within twelve months of the date of the nationwide permit's expiration, modification or revocation, unless discretionary authority has been exercised on a case-by-case basis to modify, suspend or revoke the authorization. The Action Identification Number for this project is SAW- 2016-01617.

Please note the following:

- 1) In order to compensate for impacts associated with this permit, mitigation shall be provided in accordance with the provisions outlined on the most recent version of the attached Compensatory Mitigation Responsibility Transfer Form, as committed to in your PCN. The requirements of this form, including any special conditions listed on this form, are hereby incorporated into this permit authorization.
- 2) This USACE permit does not authorize you to take a threatened or endangered species, in particular, the Northern Long-eared Bat (NLEB) (*Myotis septentrionalis*). In order to legally take a listed species, you must have separate authorization under the Endangered Species Act (ESA) (e.g., a Biological Opinion (BO) under the ESA, Section 7, with "incidental take" provisions with which you must comply). The U.S. Fish and Wildlife Service's (USFWS's) Programmatic BO titled "Northern Long-eared Bat (NLEB) Programmatic Biological Opinion for North Carolina Department of Transportation (NCDOT) Activities in Eastern North Carolina (Divisions 1-8)," dated March 25, 2015, and adopted on May 4, 2015, contains mandatory terms and conditions to implement the reasonable and prudent measures that are associated with "incidental take" that are specified in the BO. Your authorization under this USACE permit is conditioned upon your compliance with all the mandatory terms and conditions (incorporated by reference into this permit) associated with incidental take of the BO. Failure to comply with the terms and conditions associated with incidental take of the BO, where a take of the listed species occurs, would constitute an unauthorized take, and would also constitute non-compliance with your USACE permit. The USFWS is the appropriate authority to determine compliance with the terms and conditions of its BO and with the ESA.

A copy of this e-mail is being sent to the NC Division of Mitigation Services.

This response to your notification does not relieve the permittee of the responsibility to obtain any other required Federal, State or local approvals/permits.

Please let me know if you have any questions regarding this permit verification. You can call me at telephone (919) 554-4884, ext 23 or contact me via e-mail at eric.c.alsmeier@usace.army.mil

Eric Alsmeyer
 Project Manager
 Regulatory Division Office
 US Army Corps of Engineers, Wilmington District
 3331 Heritage Trade Drive, Suite 105, Wake Forest, NC 27587
 Tel: (919) 554-4884, x23
 Fax: (919) 562-0421
 Regulatory Homepage:
<http://www.saw.usace.army.mil/Missions/RegulatoryPermitProgram.aspx> (If you need information that is not yet available on our new website, please let me



North Carolina Department of Transportation

Highway Stormwater Program
STORMWATER MANAGEMENT PLAN
FOR NCDOT PROJECTS



(Version 2.06; Released June 2016)

WBS Element: 17BP.5.R.68 TIP No.: SF-340089 County(ies): Franklin Page 1 of 1

General Project Information

WBS Element:	17BP.5.R.68	TIP Number:	SF-340089	Project Type:	Bridge Replacement	Date:	10/13/2017
NCDOT Contact:	Galen Cail		Contractor / Designer:	Reid Robol, PE - Ecological Engineering			
Address:	1000 Birch Ridge Drive Raleigh, NC 27610		Address:	1151 SE Cary Parkway Suite 101 Cary, NC 27518			
	Phone:	919-707-6711		Phone:	919-557-0929		
	Email:	gcail@ncdot.gov		Email:	rrobol@ecologicaleng.com		
City/Town:	Bunn		County(ies):	Franklin			
River Basin(s):	Tar-Pamlico		CAMA County?	No			
Wetlands within Project Limits?	No						

Project Description

Project Length (lin. miles or feet):	0.12	Surrounding Land Use:	Forest, agricultural, and rural residential						
	Proposed Project			Existing Site					
Project Built-Upon Area (ac.)	1.8	ac.	1.3	ac.					
Typical Cross Section Description:	2 @ 11 ft lanes, 4.42 ft shoulders with total bridge width of 33.0 ft and a length of 85 ft.			2 @ 10 ft lanes, 2 ft shoulders with a total bridge width of 29.1 ft and a length of 76 ft.					
Annual Avg Daily Traffic (veh/hr/day):	Design/Future:	4200	Year:	2025	Existing:	2100	Year:	2012	
General Project Narrative: (Description of Minimization of Water Quality Impacts)	<p>State project 17BP.5.R.68 involves the replacement of the existing NCDOT Bridge #340089 on SR 1001 over Norris Creek. Bridge #340089 consists of 3@25' PC Channels on RC caps and timber piles that will be replaced with a 1@85', 33" Box Beam. The proposed crossing is located in Zone AE of FIRM Map number 3720270900J and was studied by Limited Detailed methods. Two modified concrete flumes are proposed and will outlet in buffer zone 2 with Rip Rap pads to dissipate the energy. No deck drains are required for the proposed bridge. Modified Concrete Flumes (MCF) were utilized due to the ground elevation at outlet locations and to minimize impacts to buffers. Using 2GIs would require a ditch to be cut through the buffer zones to get the pipe out. Additional justifications for outlets in buffer zone 2 are shown below:</p> <table border="0" style="width:100%"> <tr> <td style="width:50%"> <p>MCF on LT</p> <ul style="list-style-type: none"> The proposed driveway limited the placement of the MCF and outlet past buffer zone 2. </td> <td style="width:50%"> <p>MCF on RT</p> <ul style="list-style-type: none"> The tributary in the south east quadrant is buffered. Since the tributary is adjacent to the existing traffic facility, the entire area between the tributary and roadway is buffered. This leaves no non-buffered area to place a MCF and outlet. The MCF and outlet pad were positioned to outlet in a the small area of buffer zone 2 to minimize impacts to buffer zone 1. </td> </tr> </table>							<p>MCF on LT</p> <ul style="list-style-type: none"> The proposed driveway limited the placement of the MCF and outlet past buffer zone 2. 	<p>MCF on RT</p> <ul style="list-style-type: none"> The tributary in the south east quadrant is buffered. Since the tributary is adjacent to the existing traffic facility, the entire area between the tributary and roadway is buffered. This leaves no non-buffered area to place a MCF and outlet. The MCF and outlet pad were positioned to outlet in a the small area of buffer zone 2 to minimize impacts to buffer zone 1.
<p>MCF on LT</p> <ul style="list-style-type: none"> The proposed driveway limited the placement of the MCF and outlet past buffer zone 2. 	<p>MCF on RT</p> <ul style="list-style-type: none"> The tributary in the south east quadrant is buffered. Since the tributary is adjacent to the existing traffic facility, the entire area between the tributary and roadway is buffered. This leaves no non-buffered area to place a MCF and outlet. The MCF and outlet pad were positioned to outlet in a the small area of buffer zone 2 to minimize impacts to buffer zone 1. 								

Waterbody Information

Surface Water Body (1):	Norris Creek		NCDWR Stream Index No.:	28-30-3				
NCDWR Surface Water Classification for Water Body	Primary Classification:	Class C						
	Supplemental Classification:	Nutrient Sensitive Waters (NSW)						
Other Stream Classification:	None							
Impairments:	None							
Aquatic T&E Species?	No	Comments:						
NRTR Stream ID:							Buffer Rules in Effect:	Tar-Pamlico
Project Includes Bridge Spanning Water Body?	Yes	Deck Drains Discharge Over Buffer?	No	Dissipator Pads Provided in Buffer?				Yes
Deck Drains Discharge Over Water Body?	No	(If yes, provide justification in the General Project Narrative)			(If yes, describe in the General Project Narrative; if no, justify in the General Project Narrative)			
(If yes, provide justification in the General Project Narrative)								

TIP PROJECT: 17BP.5.R.68

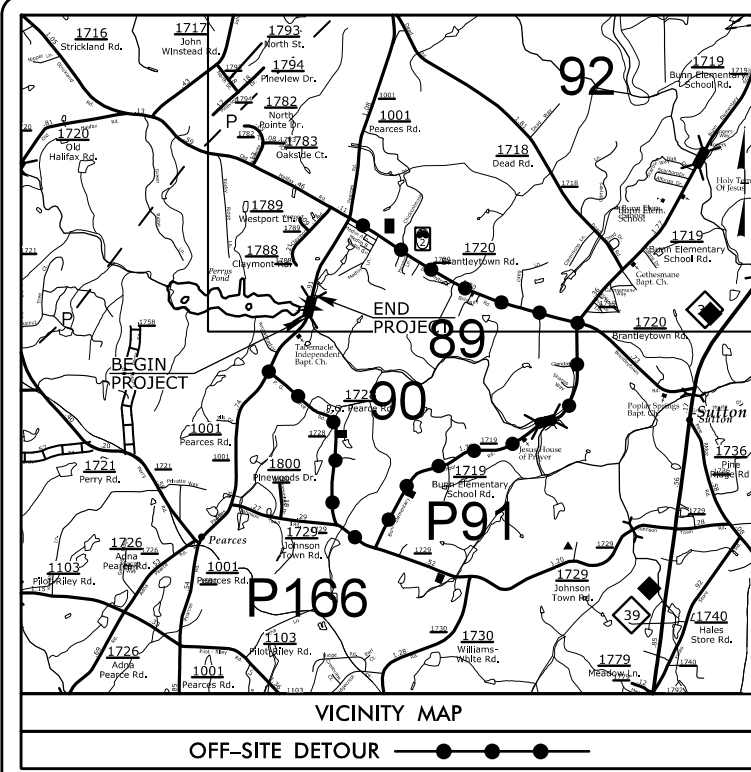

See Sheet 1A For Index of Sheets
 See Sheet 1B For Conventional Symbols

STATE OF NORTH CAROLINA
 DIVISION OF HIGHWAYS
FRANKLIN COUNTY

**LOCATION: BRIDGE NO. 89 OVER NORRIS CREEK ON
 SR 1001 (PEARCES RD.)**

TYPE OF WORK: GRADING, DRAINAGE, PAVING, AND STRUCTURE

STATE	STATE PROJECT REFERENCE NO.	SHEET NO.	TOTAL SHEETS
N.C.	17BP.5.R.68	1	
STATE PROJ. NO.	F.A. PROJ. NO.	DESCRIPTION	
17BP.5.R.68	N/A	PE	
17BP.5.R.68	N/A	ROW /UTILITIES	
17BP.5.R.68	N/A	CONSTRUCTION	

**PERMIT DRAWING
 SHEET ___ OF ___**



WETLAND AND SURFACE WATER IMPACTS PERMIT

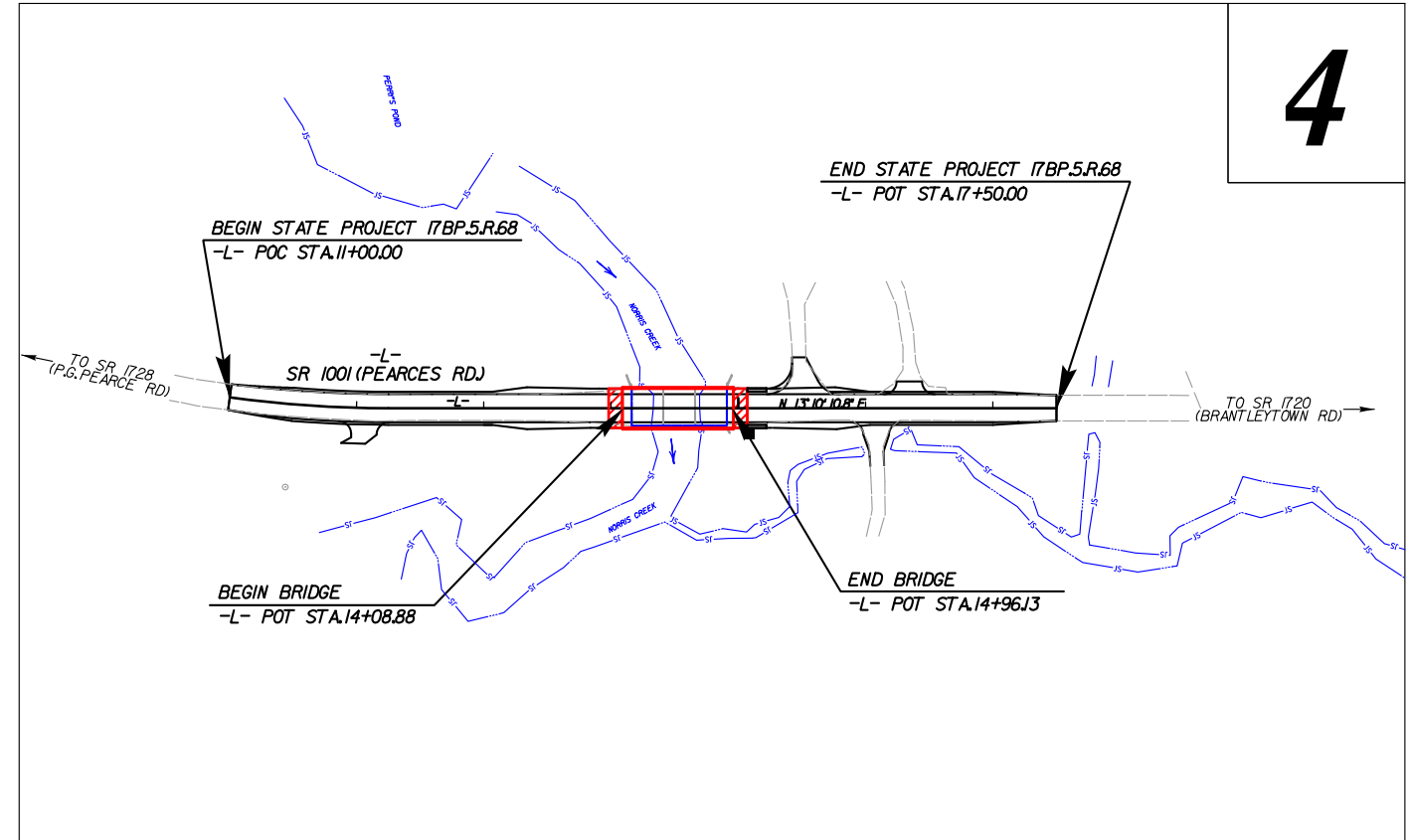

CLEARING ON THIS PROJECT SHALL BE TO LIMITS ESTABLISHED USING METHOD III.
 THIS PROJECT IS NOT WITHIN ANY MUNICIPAL BOUNDARIES.

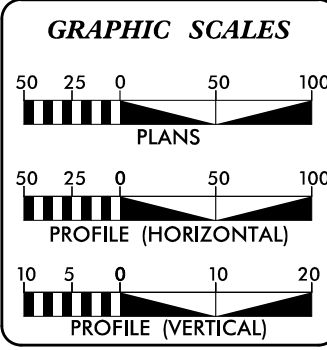

DESIGN DATA

ADT = 2250
 V = 50 MPH
 CLASS = RURAL LOCAL
 SUBREGIONAL TIER

PROJECT LENGTH

LENGTH ROADWAY STATE PROJECT 17BP.5.R.68 = 0.106 mi.
 LENGTH STRUCTURES STATE PROJECT 17BP.5.R.68 = 0.017 mi.
 TOTAL LENGTH STATE PROJECT 17BP.5.R.68 = 0.123 mi.

Prepared in the Offices of:

421 FAYETTEVILLE ST., STE. 400
 RALEIGH, NC 27601
 T 919.380.8750

NC FIRM LICENSE No. P-1148
 1151 SE Cary Parkway, Suite 101
 Cary, NC 27513
 (919) 557-9029

2012 STANDARD SPECIFICATIONS

RIGHT OF WAY DATE:
 JUNE 19, 2017
RIGHT OF WAY COMPLETE:

LETTING DATE:
 MARCH 5, 2018

ANDY YOUNG, PE
PROJECT ENGINEER

MICHAEL BURNS, PE
PROJECT DESIGN ENGINEER

LISA GILCHRIST, EI
NC DOT CONTACT

HYDRAULICS ENGINEER



SIGNATURE: _____ P.E.

ROADWAY DESIGN ENGINEER

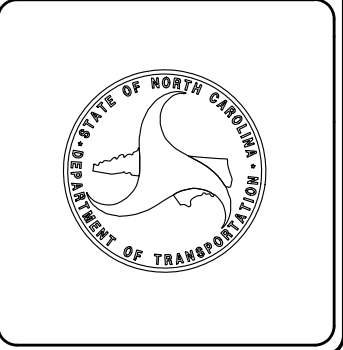
SIGNATURE: _____ P.E.



I:\33451\AM R:\Hydraulics\PERMITS_Environmental\Drawings\340089_wet_perm_TSH.dgn erlcbg

PROJECT REFERENCE NO. 17BP.5.R.68	SHEET NO. 4
RW SHEET NO.	
ROADWAY DESIGN ENGINEER	HYDRAULICS ENGINEER
 	

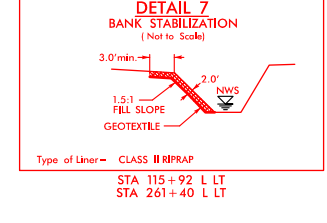
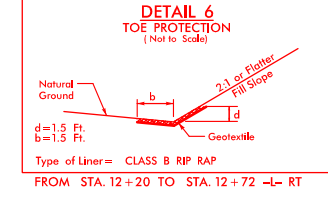
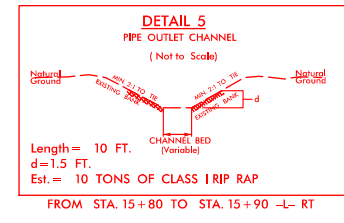
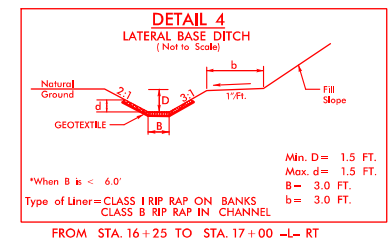
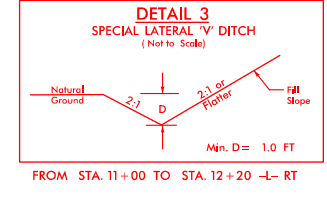
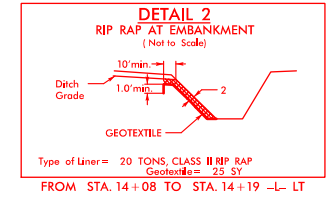
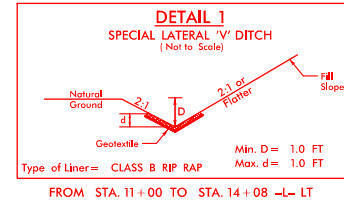

PERMIT DRAWING SHEET OF

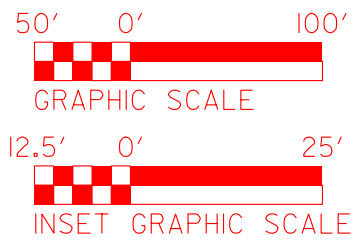

S S DENOTES IMPACTS IN SURFACE WATER
TS TS DENOTES TEMPORARY IMPACTS IN SURFACE WATER

GRADING NOTE:
LIMIT TREE CLEARING ON PARCELS 1 & 3.
ENGINEER SHALL BE DIRECTED

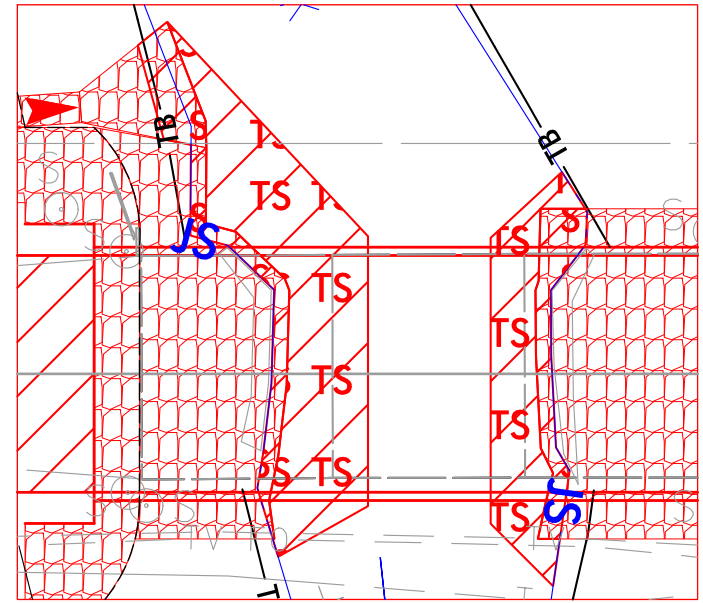
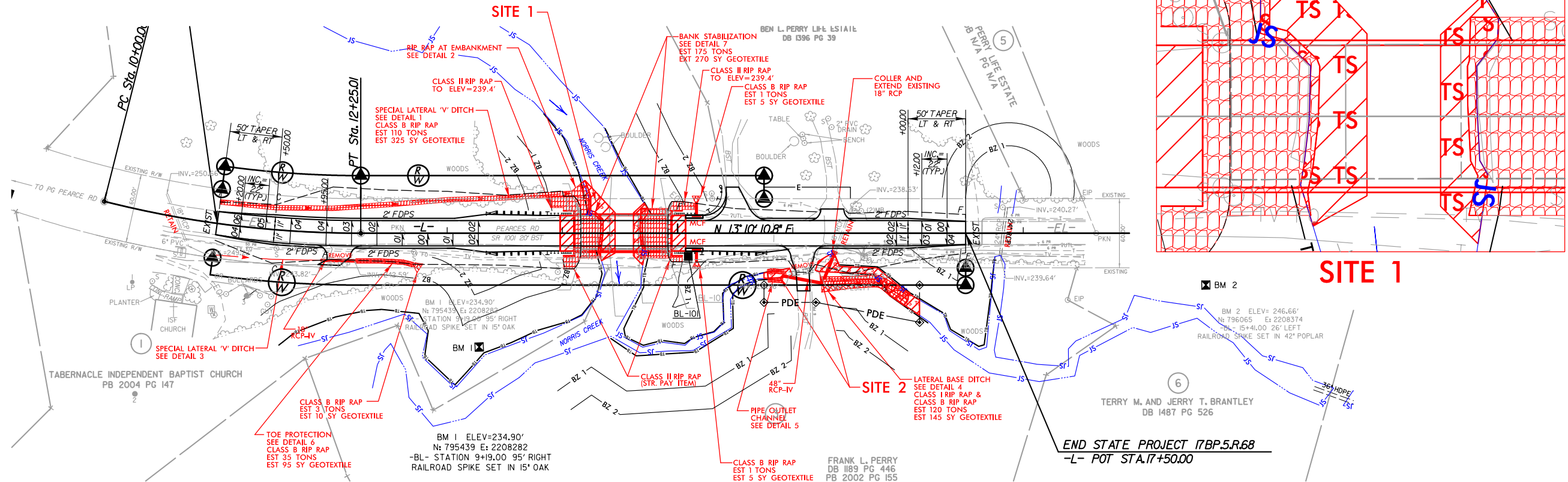

SITE 1

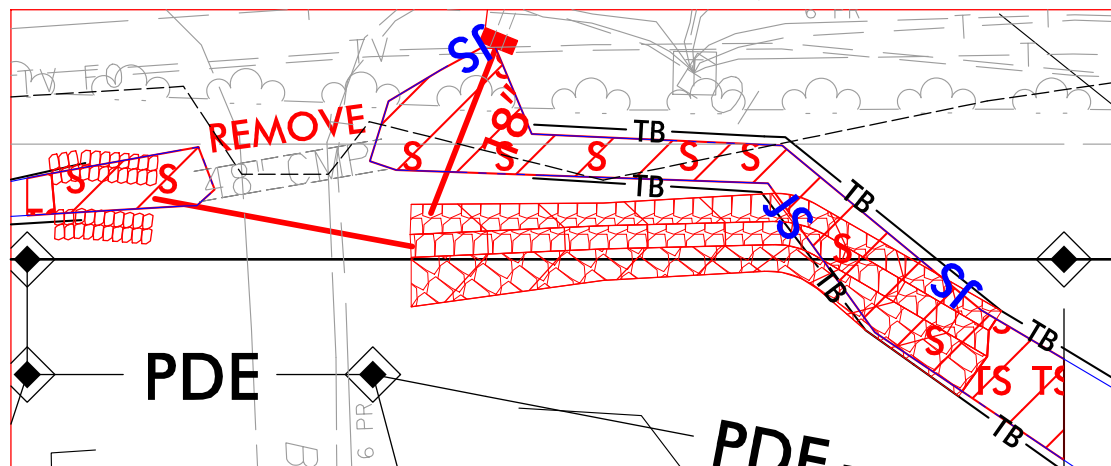

SITE 2

NOTE: THE CONTRACTOR MUST COMPLETELY REMOVE ALL EXISTING AND OLDER BRIDGE COMPONENTS. THE REMOVAL OF THE CONCRETE ABUTMENTS MUST BE DONE USING APPROVED NCDOT BMP METHODS. THE PLACEMENT OF THE IMPERVIOUS DIKE IS CONSIDERED INCIDENTAL TO REMOVAL OF THE EXISTING CONCRETE ABUTMENTS AND INSTALLATION OF THE BANK STABILIZATION.

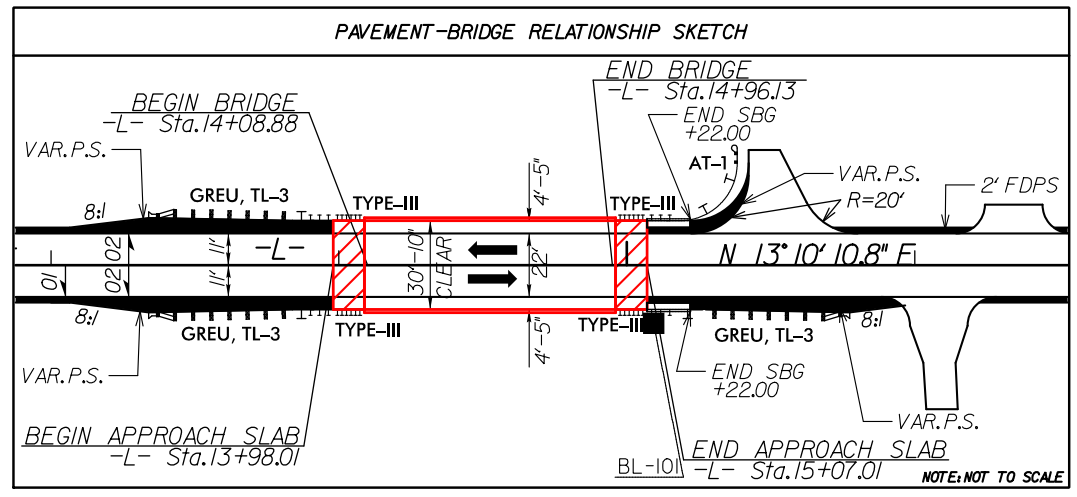

FOR -L- PROFILE, SEE SHEET 5
 FOR STRUCTURE PLANS, SEE SHEETS S-1 THRU S-16
 ALL DRIVEWAY RADII ARE 10' UNLESS OTHERWISE NOTED

REVISED PROPERTY LINE BETWEEN PARCEL NO. 2 & 4 RIGHT SIDE

8/17/99
 ROW REV. - AUGUST 1, 2017 - REVISED PROPERTY LINE BETWEEN PARCEL NO. 2 & 4 RIGHT SIDE
 H:\3755 AM\pics\PERMITS_Environmental\Drawings\340089_wet_prm_PSH04.dgn

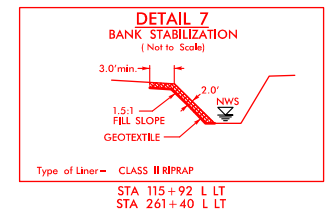
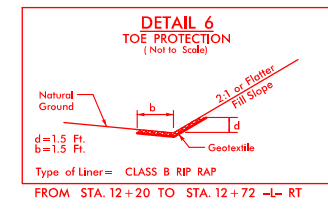
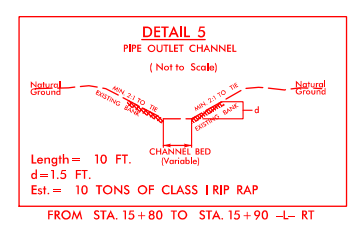
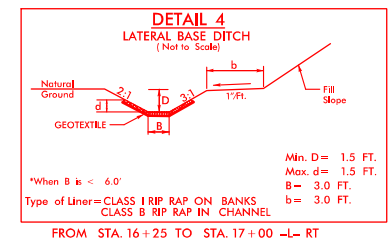
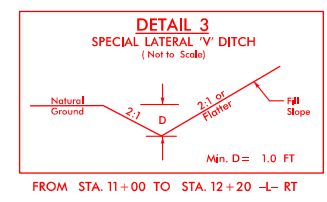
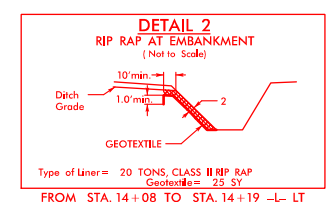
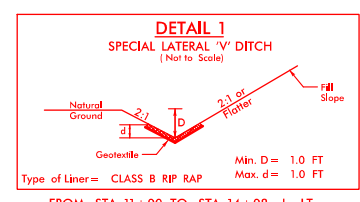

PERMIT DRAWING SHEET OF

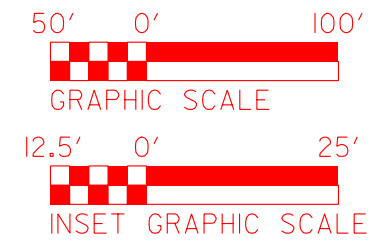

SS DENOTES IMPACTS IN SURFACE WATER

TS DENOTES TEMPORARY IMPACTS IN SURFACE WATER

GRADING NOTE:
LIMIT TREE CLEARING ON PARCELS 1 & 3.
ENGINEER SHALL BE DIRECTED

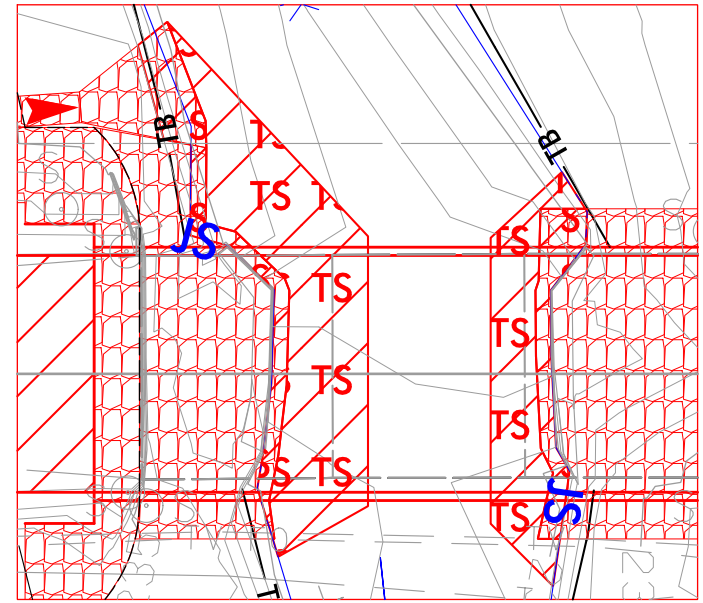
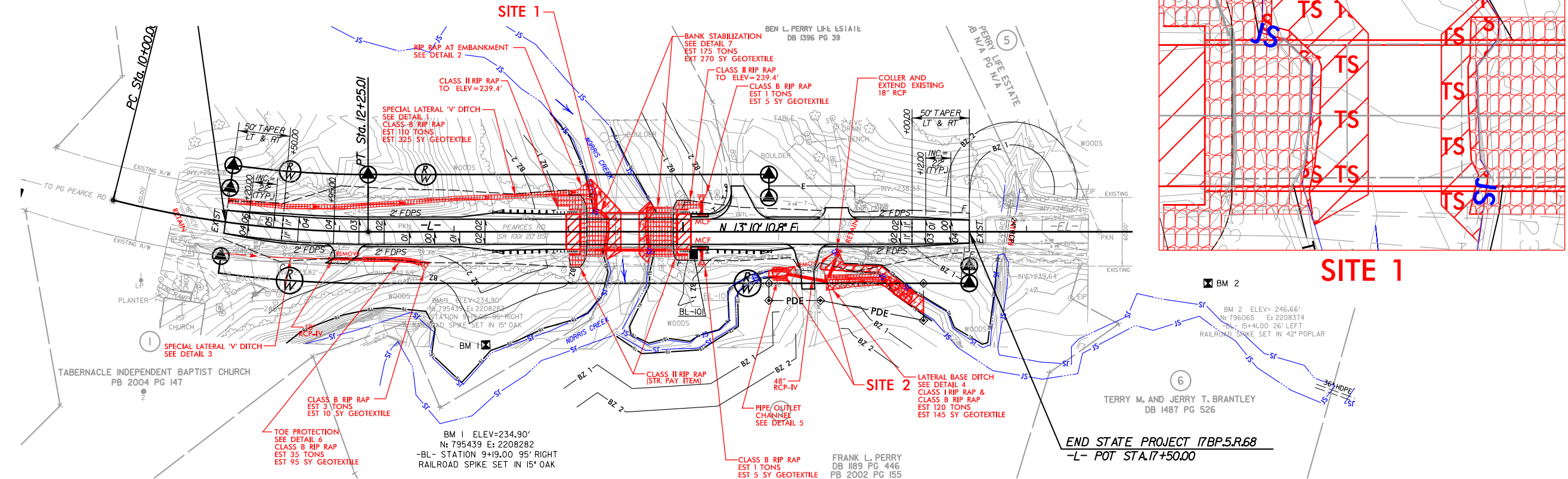

SITE 1

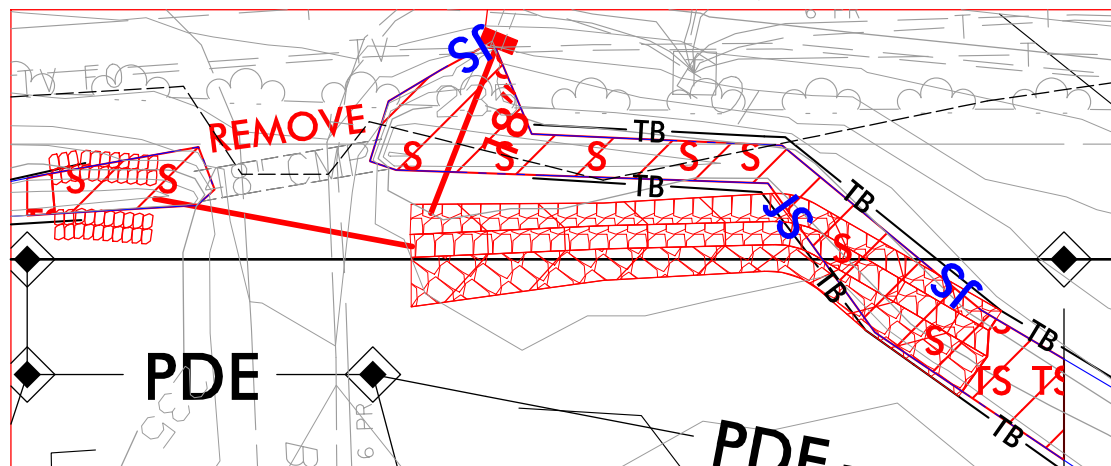

SITE 2

NOTE: THE CONTRACTOR MUST COMPLETELY REMOVE ALL EXISTING AND OLDER BRIDGE COMPONENTS. THE REMOVAL OF THE CONCRETE ABUTMENTS MUST BE DONE USING APPROVED NCDOT BMP METHODS. THE PLACEMENT OF THE IMPERVIOUS DIKE IS CONSIDERED INCIDENTAL TO REMOVAL OF THE EXISTING CONCRETE ABUTMENTS AND INSTALLATION OF THE BANK STABILIZATION.

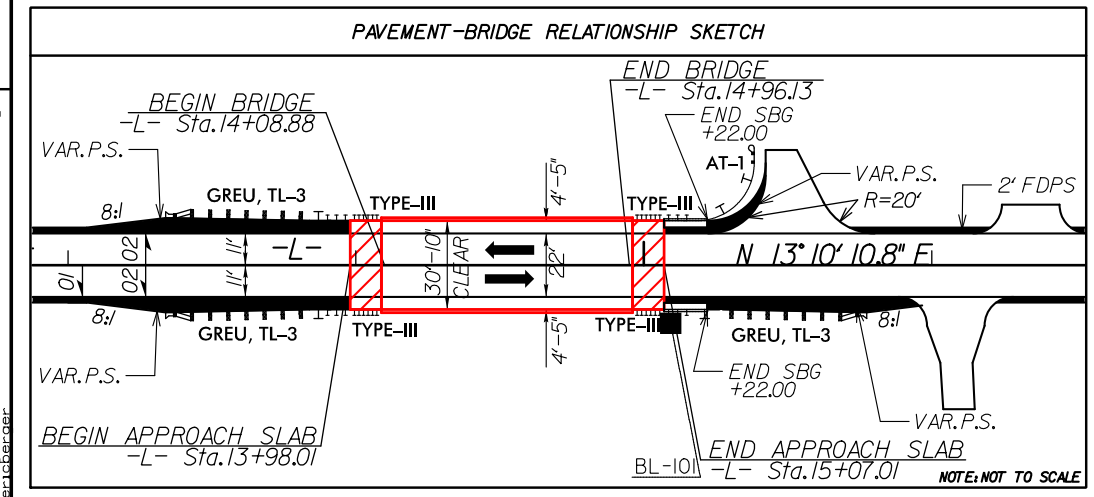

FOR -L- PROFILE, SEE SHEET 5

FOR STRUCTURE PLANS, SEE SHEETS S-1 THRU S-16

ALL DRIVEWAY RADII ARE 10' UNLESS OTHERWISE NOTED

REVISED PROPERTY LINE BETWEEN PARCEL NO. 2 & 4 RIGHT SIDE

8/17/99
11:40 AM
C:\Users\PERMITS_Environmental\Drawings\17BP.5.R.68\17BP.5.R.68.dwg

WETLAND AND SURFACE WATER IMPACTS SUMMARY

Site No.	Station (From/To)	Structure Size / Type	WETLAND IMPACTS					SURFACE WATER IMPACTS				
			Permanent Fill In Wetlands (ac)	Temp. Fill In Wetlands (ac)	Excavation in Wetlands (ac)	Mechanized Clearing in Wetlands (ac)	Hand Clearing in Wetlands (ac)	Permanent SW impacts (ac)	Temp. SW impacts (ac)	Existing Channel Impacts Permanent (ft)	Existing Channel Impacts Temp. (ft)	Natural Stream Design (ft)
1	14+16/14+73 -L- LT	1@85' 33" BOX BEAM W/ 4' CAPS						< 0.01	0.02	108	91	
2	15+78/17+06 -L- RT	1@85' 33" BOX BEAM W/ 4' CAPS						0.02	< 0.01	109	15	79
TOTALS*:								0.03	0.02	217	106	79

*Rounded totals are sum of actual impacts

NOTES:

	Perm. SW Impacts (sq. ft.)	Temp. SW Impacts (sq. ft.)
Site 1	307	873
Site 2	861	154
Total	1168	1027

NC DEPARTMENT OF TRANSPORTATION
 DIVISION OF HIGHWAYS
 9/25/2017
 FRANKLIN COUNTRY
 17BP.5.R.68
 SF-340089
 SHEET XXX OF XXX



North Carolina Department of Transportation

Highway Stormwater Program
STORMWATER MANAGEMENT PLAN
FOR NCDOT PROJECTS



(Version 2.06; Released June 2016)

WBS Element: 17BP.5.R.68 TIP No.: SF-340089 County(ies): Franklin Page 1 of 1

General Project Information

WBS Element:	17BP.5.R.68	TIP Number:	SF-340089	Project Type:	Bridge Replacement	Date:	10/13/2017
NCDOT Contact:	Galen Cail		Contractor / Designer:	Reid Robol, PE - Ecological Engineering			
Address:	1000 Birch Ridge Drive Raleigh, NC 27610		Address:	1151 SE Cary Parkway Suite 101 Cary, NC 27518			
	Phone:	919-707-6711		Phone:	919-557-0929		
	Email:	gcail@ncdot.gov		Email:	rrobol@ecologicaleng.com		
City/Town:	Bunn		County(ies):	Franklin			
River Basin(s):	Tar-Pamlico		CAMA County?	No			
Wetlands within Project Limits?	No						

Project Description

Project Length (lin. miles or feet):	0.12	Surrounding Land Use:	Forest, agricultural, and rural residential						
	Proposed Project			Existing Site					
Project Built-Upon Area (ac.)	1.8	ac.	1.3	ac.					
Typical Cross Section Description:	2 @ 11 ft lanes, 4.42 ft shoulders with total bridge width of 33.0 ft and a length of 85 ft.			2 @ 10 ft lanes, 2 ft shoulders with a total bridge width of 29.1 ft and a length of 76 ft.					
Annual Avg Daily Traffic (veh/hr/day):	Design/Future:	4200	Year:	2025	Existing:	2100	Year:	2012	
General Project Narrative: (Description of Minimization of Water Quality Impacts)	<p>State project 17BP.5.R.68 involves the replacement of the existing NCDOT Bridge #340089 on SR 1001 over Norris Creek. Bridge #340089 consists of 3@25' PC Channels on RC caps and timber piles that will be replaced with a 1@85', 33" Box Beam. The proposed crossing is located in Zone AE of FIRM Map number 3720270900J and was studied by Limited Detailed methods. Two modified concrete flumes are proposed and will outlet in buffer zone 2 with Rip Rap pads to dissipate the energy. No deck drains are required for the proposed bridge. Modified Concrete Flumes (MCF) were utilized due to the ground elevation at outlet locations and to minimize impacts to buffers. Using 2GIs would require a ditch to be cut through the buffer zones to get the pipe out. Additional justifications for outlets in buffer zone 2 are shown below:</p> <table border="0" style="width:100%"> <tr> <td style="width:50%"> <p>MCF on LT</p> <ul style="list-style-type: none"> The proposed driveway limited the placement of the MCF and outlet past buffer zone 2. </td> <td style="width:50%"> <p>MCF on RT</p> <ul style="list-style-type: none"> The tributary in the south east quadrant is buffered. Since the tributary is adjacent to the existing traffic facility, the entire area between the tributary and roadway is buffered. This leaves no non-buffered area to place a MCF and outlet. The MCF and outlet pad were positioned to outlet in a the small area of buffer zone 2 to minimize impacts to buffer zone 1. </td> </tr> </table>							<p>MCF on LT</p> <ul style="list-style-type: none"> The proposed driveway limited the placement of the MCF and outlet past buffer zone 2. 	<p>MCF on RT</p> <ul style="list-style-type: none"> The tributary in the south east quadrant is buffered. Since the tributary is adjacent to the existing traffic facility, the entire area between the tributary and roadway is buffered. This leaves no non-buffered area to place a MCF and outlet. The MCF and outlet pad were positioned to outlet in a the small area of buffer zone 2 to minimize impacts to buffer zone 1.
<p>MCF on LT</p> <ul style="list-style-type: none"> The proposed driveway limited the placement of the MCF and outlet past buffer zone 2. 	<p>MCF on RT</p> <ul style="list-style-type: none"> The tributary in the south east quadrant is buffered. Since the tributary is adjacent to the existing traffic facility, the entire area between the tributary and roadway is buffered. This leaves no non-buffered area to place a MCF and outlet. The MCF and outlet pad were positioned to outlet in a the small area of buffer zone 2 to minimize impacts to buffer zone 1. 								

Waterbody Information

Surface Water Body (1):	Norris Creek		NCDWR Stream Index No.:	28-30-3			
NCDWR Surface Water Classification for Water Body	Primary Classification:		Class C				
	Supplemental Classification:		Nutrient Sensitive Waters (NSW)				
Other Stream Classification:	None						
Impairments:	None						
Aquatic T&E Species?	No	Comments:					
NRTR Stream ID:				Buffer Rules in Effect:	Tar-Pamlico		
Project Includes Bridge Spanning Water Body?	Yes	Deck Drains Discharge Over Buffer?	No	Dissipator Pads Provided in Buffer?	Yes		
Deck Drains Discharge Over Water Body?	No	(If yes, provide justification in the General Project Narrative)		(If yes, describe in the General Project Narrative; if no, justify in the General Project Narrative)			
	(If yes, provide justification in the General Project Narrative)						

STATE	STATE PROJECT REFERENCE NO.	SHEET NO.	TOTAL SHEETS
N.C.	17BP.5.R.68	1	
STATE PROJ. NO.	F.A. PROJ. NO.	DESCRIPTION	
17BP.5.R.68	N/A	PE	
17BP.5.R.68	N/A	ROW / UTILITIES	
17BP.5.R.68	N/A	CONSTRUCTION	

BUFFER DRAWING SHEET OF



STATE OF NORTH CAROLINA
DIVISION OF HIGHWAYS

FRANKLIN COUNTY

LOCATION: BRIDGE NO. 89 OVER NORRIS CREEK ON
SR 1001 (PEARCES RD.)

TYPE OF WORK: GRADING, DRAINAGE, PAVING, AND STRUCTURE

BUFFER IMPACTS PERMIT

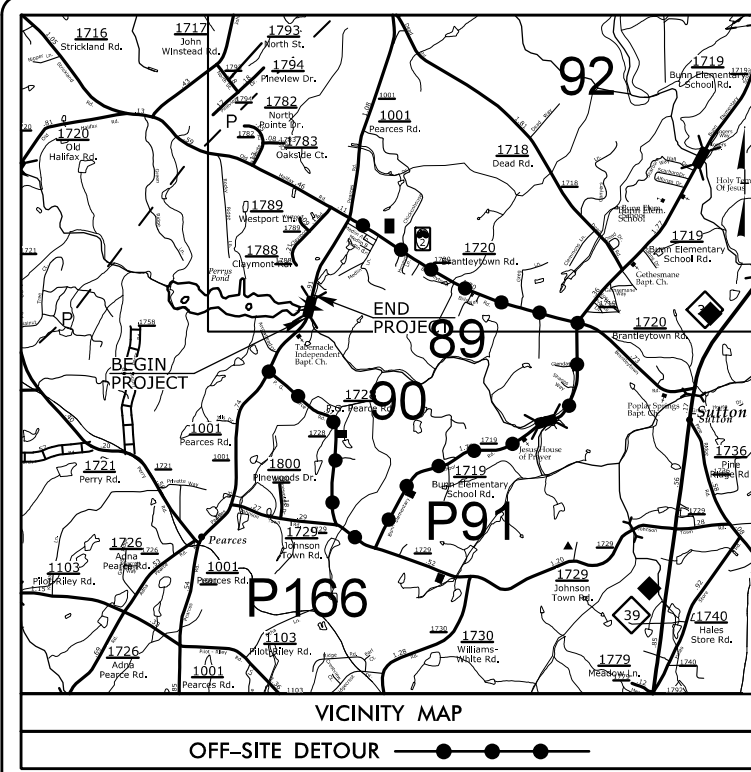

See Sheet 1A For Index of Sheets
See Sheet 1B For Conventional Symbols

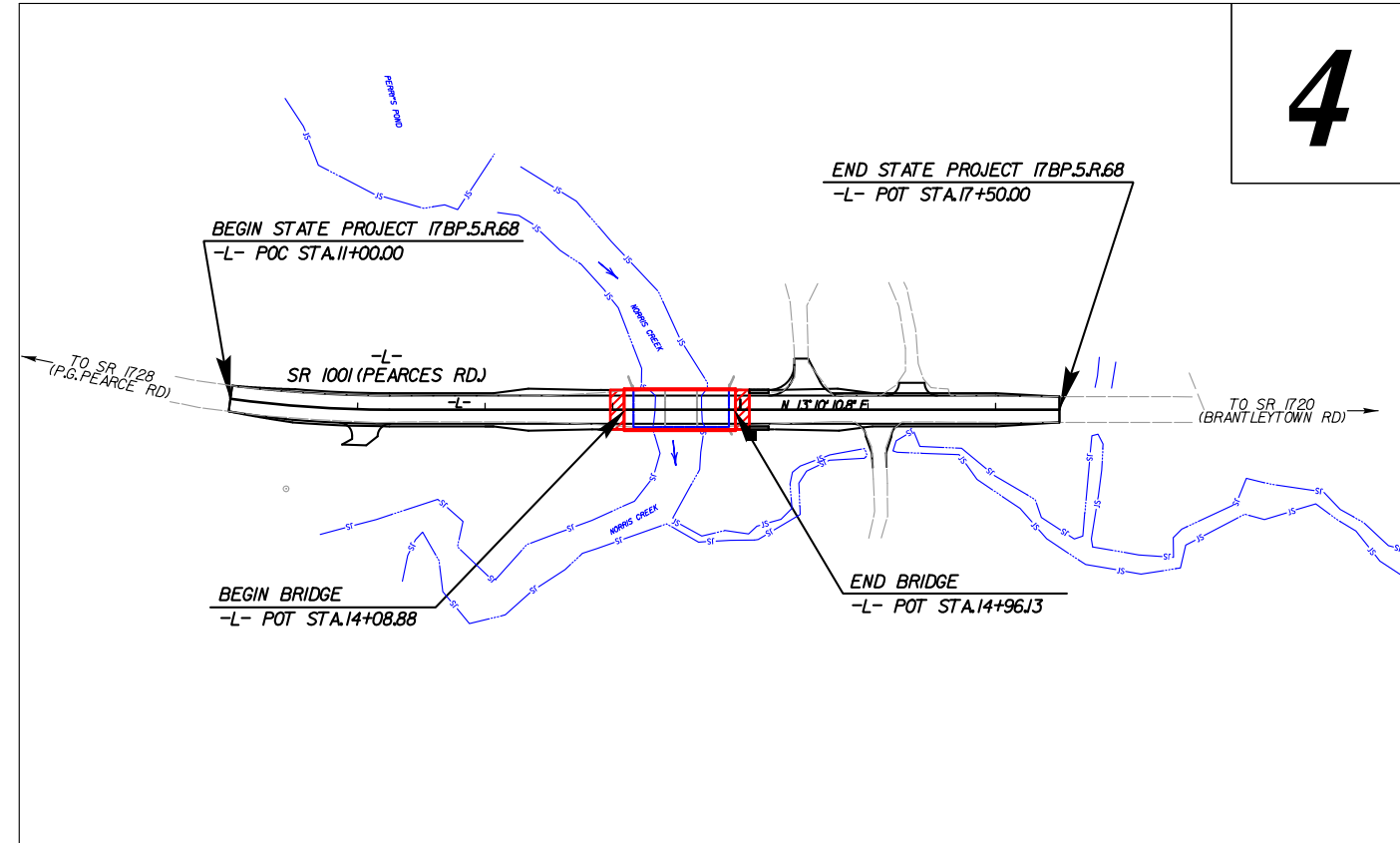

CLEARING ON THIS PROJECT SHALL BE TO LIMITS ESTABLISHED USING METHOD III.
THIS PROJECT IS NOT WITHIN ANY MUNICIPAL BOUNDARIES.

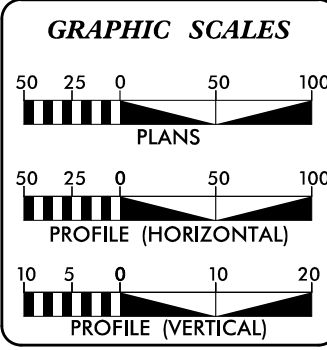

DESIGN DATA

ADT = 2250
V = 50 MPH
CLASS = RURAL LOCAL
SUBREGIONAL TIER

PROJECT LENGTH

LENGTH ROADWAY STATE PROJECT 17BP.5.R.68 = 0.106 mi.
LENGTH STRUCTURES STATE PROJECT 17BP.5.R.68 = 0.017 mi.
TOTAL LENGTH STATE PROJECT 17BP.5.R.68 = 0.123 mi.

Prepared in the Offices of:

2012 STANDARD SPECIFICATIONS

RIGHT OF WAY DATE: JUNE 19, 2017
RIGHT OF WAY COMPLETE:

LETTING DATE: MARCH 5, 2018

ANDY YOUNG, PE
PROJECT ENGINEER

MICHAEL BURNS, PE
PROJECT DESIGN ENGINEER

LISA GILCHRIST, EI
NCDOT CONTACT

HYDRAULICS ENGINEER

SIGNATURE: _____ P.E.

ROADWAY DESIGN ENGINEER

SIGNATURE: _____ P.E.

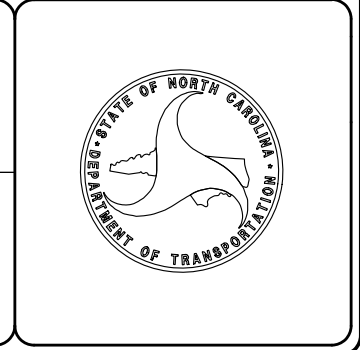

09/28/17
 9:13:39 AM
 R:\Hydraulics\PERMITS_Environmental\Drawings\340089_buf_prm_TSH.dgn
 erlcb@dot.gov

TIP PROJECT: 17BP.5.R.68

CONTRACT:

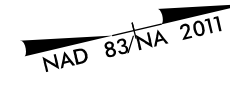
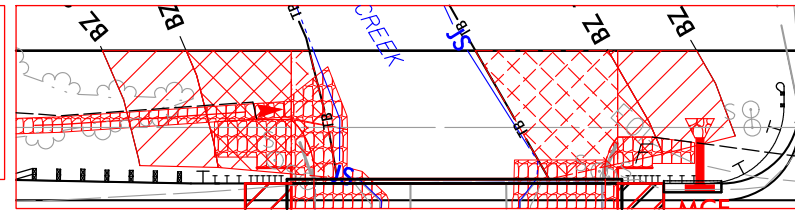
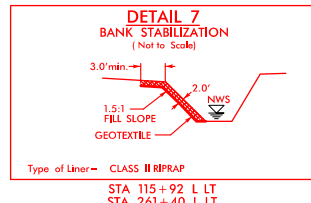
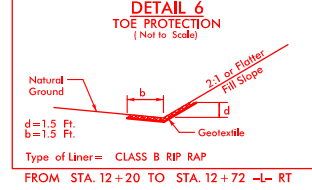
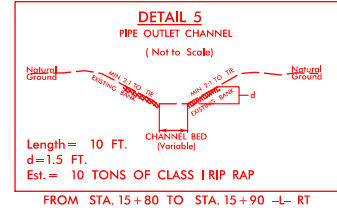
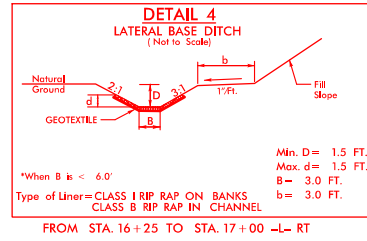
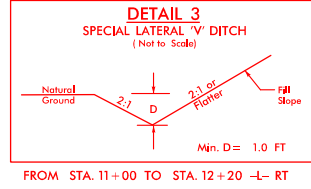
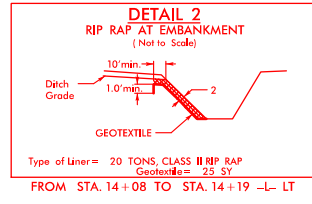
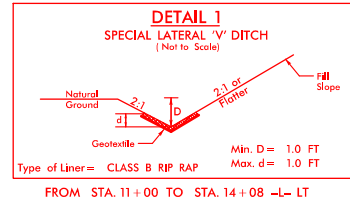
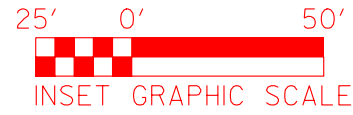
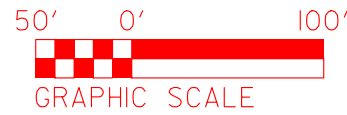

GRADING NOTE:
LIMIT TREE CLEARING ON PARCELS 1 & 3.
ENGINEER SHALL BE DIRECTED

BUFFER DRAWING SHEET OF

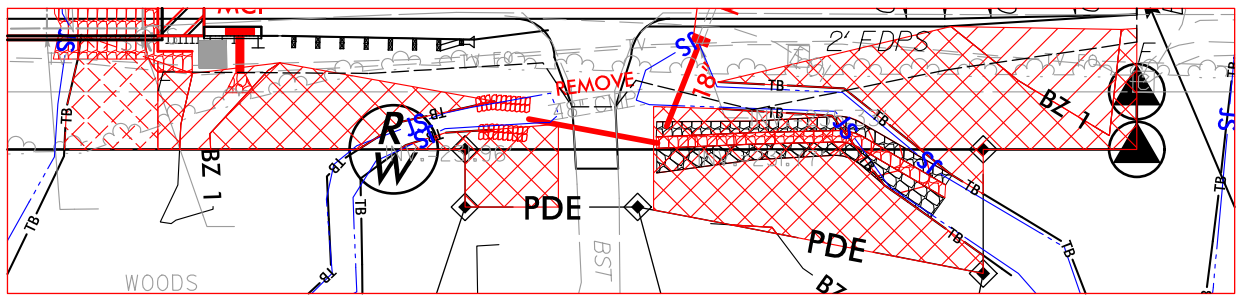
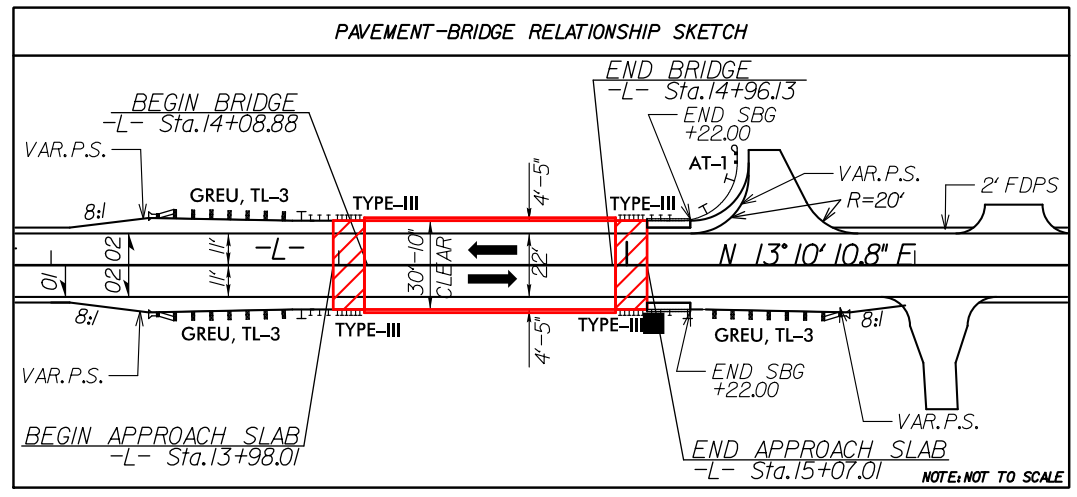
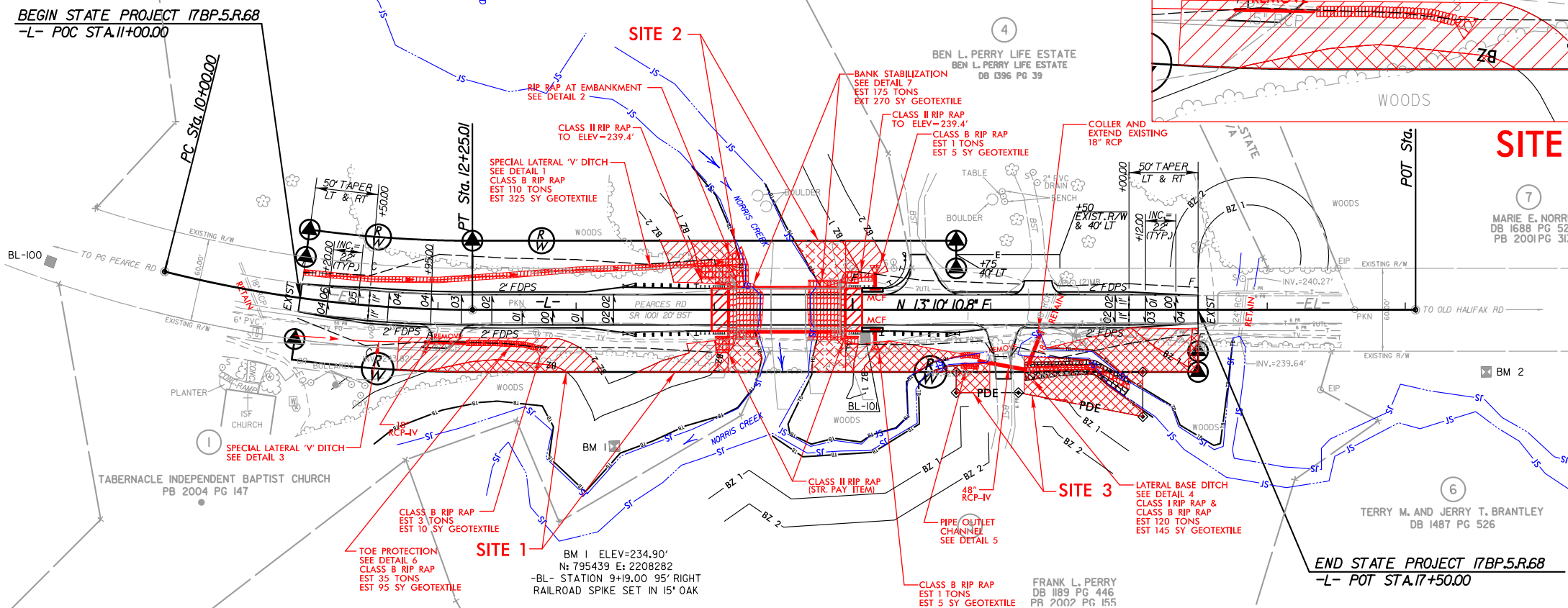

NOTE: THE CONTRACTOR MUST COMPLETELY REMOVE ALL EXISTING AND OLDER BRIDGE COMPONENTS. THE REMOVAL OF THE CONCRETE ABUTMENTS MUST BE DONE USING APPROVED NCDOT BMP METHODS. THE PLACEMENT OF THE IMPERVIOUS DIKE IS CONSIDERED INCIDENTAL TO REMOVAL OF THE EXISTING CONCRETE ABUTMENTS AND INSTALLATION OF THE BANK STABILIZATION.

- FOR -L- PROFILE, SEE SHEET 5
- FOR STRUCTURE PLANS, SEE SHEETS 5-1 THRU 5-16
- ALL DRIVEWAY RADII ARE 10' UNLESS OTHERWISE NOTED

REVISIONS
ROW REV. - AUGUST 1, 2017 - REVISED PROPERTY LINE BETWEEN PARCEL NO. 2 & 4 RIGHT SIDE

8/17/99
R:\17\17043\AM\17043\17043\PERMITS_Environmental\Drawings\340089_buf_prm_PSH04.dgn
P:\17\17043\AM\17043\17043\PERMITS_Environmental\Drawings\340089_buf_prm_PSH04.dgn

BUFFER IMPACTS SUMMARY

SITE NO.	STRUCTURE SIZE / TYPE	STATION (FROM/TO)	IMPACT									BUFFER REPLACEMENT	
			TYPE			ALLOWABLE			MITIGABLE			ZONE 1 (ft ²)	ZONE 2 (ft ²)
			ROAD CROSSING	BRIDGE	PARALLEL IMPACT	ZONE 1 (ft ²)	ZONE 2 (ft ²)	TOTAL (ft ²)	ZONE 1 (ft ²)	ZONE 2 (ft ²)	TOTAL (ft ²)		
1	1@85' 33" BOX BEAM W/ 4' CAPS	14+10/14+34 -L- RT		X		621	0	621					
1	1@85' 33" BOX BEAM W/ 4' CAPS	11+73/14+10 -L- RT			X				777	3473	4250		
2	1@85' 33" BOX BEAM W/ 4' CAPS	14+10/14+95 -L- LT		X		1157	5	1162					
2	1@85' 33" BOX BEAM W/ 4' CAPS	13+61/15+26 -L- LT			X				861	1172	2033		
3	1@85' 33" BOX BEAM W/ 4' CAPS	14+71/14+95 -L- RT		X		602	0	602					
3	1@85' 33" BOX BEAM W/ 4' CAPS	14+95/17+50 -L- RT			X				5478	933	6411		
TOTAL:						2380	5	2385	7116	5578	12694	0.0	0.0

N.C. DEPT. OF TRANSPORTATION
 DIVISION OF HIGHWAYS

 FRANKLIN COUNTY
 PROJECT: 17BP.5.R.68 (SF-340089)

 10/23/2017
 SHEET OF